

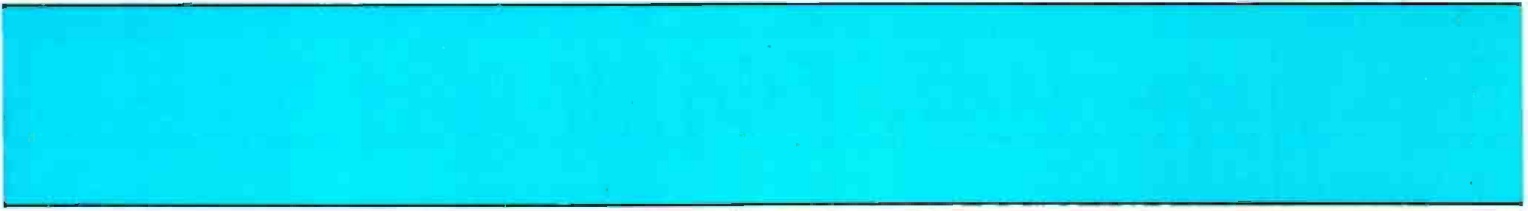

49810JKUOWA325COM11 0383 9999
KUON RADIO
O S 50 UNIT OF WASH
325 COMMUNICATIONS BLDG
SEATTLE WA 98105



TECHNOLOGY YOU CAN TOUCH

The Otari MTR-10 Series 1/4" & 1/2" Mastering/Production Recorders



The MTR-10 Series are fully microprocessor controlled mastering/production recorders available in four recording formats: 1/4" full-track; 1/4" two channel; 1/2" two channel and 1/2" four channel. They are the ultimate in analog tape recorder performance and are the embodiment of our dedication to innovation and quality. Practical, efficient and exclusive transport and electronic features abound. Unprecedented control and flexibility are now yours because they are the only mastering recorders in their class which feature an extremely sophisticated, full-function, ten memory locator. For the stringent requirements of multi-media production all versions of the MTR-10 Series machines easily interface with any SMPTE-based video editing system, machine controller or synchronizer.

Working closely with industry leaders in broadcast, film and recording production, we have engineered a recorder that is ready to meet any audio professional's challenge. Superb reliability, the hallmark of Otari's reputation, assures a professional's investment in today's business... secures it for tomorrow's.

The MTR-10's are engineered like no other tape machines in the world; with the qualities you can hear and feel.



OTARI Technology You Can Touch.

Otari Corporation, 2 Davis Drive, Belmont, CA 94002
Tel: (415) 592-8311 Telex: 910-376-4890



Circle 10 on Reader Service Card

©Otari Corporation

Publisher
Larry Zide

Associate Publisher
Elaine Zide

Editor
John M. Woram

Managing Editor
Mark B. Waldstein

European Editor
John Borwick

Production & Layout
Kathi Lippe

Advertising Coordinator
Karen Cohn

Copy Editor
Joyce Soricillo

Classified Advertising
Carol Vitelli

Book Sales
Lydia Calogrides

Circulation Manager
Eloise Beach

Graphics
K & S Graphics

Typography
Spartan Phototype Co.

sales offices

Roy McDonald Associates, Inc.

Dallas, Texas 75207
First Continental Bank Bldg.
5801 Marvin D. Love Freeway
Suite 303
(214) 941-4461

**Denver, Colorado Area
Englewood, Colorado 80112**

14 Inverness Dr. East
Bldg. 1—Penthouse
(303) 771-8181

Houston, Texas 77036

6901 Corporate Drive
Suite 210
(713) 988-5005

**Los Angeles Area
Glendale, California 91204**

424 West Colorado Street
Suite 201
(213) 244-8176

**Portland Area
Hillsboro, Oregon 97123**

510 South First
P.O. Box 696
(503) 640-2011

**San Francisco Area
Emeryville, California 94608**

265 Baybridge Office Plaza
5801 Christie Avenue
(415) 653-2122

**Sagamore Publishing Co.
New York**

Plainview, NY 11803
1120 Old Country Rd.
(516) 433-6530

About
The
Cover

• Editel's new post production audio mix room features a Solid State Logic Automated Console, Studer multi-track tape machines, SMPTE interlock and enough room for up to a dozen clients to kibbitz in the lap of art deco luxury. Photo courtesy of Mark Ross.



MARCH 1983 VOLUME 17, NO. 3

FEATURES

DIGITAL BROADCASTING: UPCOMING REVOLUTION? Vladimir Nikanorov
29

AUTOMATED AUDIO TEST SYSTEMS FOR PROFESSIONAL AUDIO PERFORMANCE REQUIREMENTS Bob Metzler
39

DESIGNING AUDIO FOR VIDEO Vin Gizzi
44

TIPS ON RECORDING FROM THE TELEPHONE Skip Pizzi
50

A db TEST REPORT: THE MCI JH-800 CONSOLE: A SURVIVAL REPORT Ken Pohlmann
55

DEPARTMENTS

| LETTERS | EDITORIAL | CLASSIFIED |
|----------------------------|-----------|---------------|
| 6 | 28 | 62 |
| THEORY AND PRACTICE | | Ken Pohlmann |
| 10 | | |
| DIGITAL AUDIO | | Barry Blesser |
| 16 | | |
| SOUND REINFORCEMENT | | John Eargle |
| 20 | | |
| SOUND WITH IMAGES | | Len Feldman |
| 22 | | |
| NEW PRODUCTS AND SERVICES | | |
| 61 | | |
| PEOPLE, PLACES, HAPPENINGS | | |
| 64 | | |

db, the Sound Engineering Magazine (ISSN 0011-7145) is published monthly by Sagamore Publishing Company, Inc. Entire contents copyright © 1983 by Sagamore Publishing Co., 1120 Old Country Road, Plainview, N. Y. 11803. Telephone (516) 433-6530. db is published for those individuals and firms in professional audio-recording, broadcast, audio-visual, sound reinforcement, consultants, video recording, film sound, etc. Application should be made on the subscription form in the rear of each issue. Subscriptions are \$15.00 per year (\$28.00 per year outside U.S. Possessions, \$16.00 per year Canada) in U.S. funds. Single copies are \$1.95 each. Editorial, Publishing and Sales Offices, 1120 Old Country Road, Plainview, New York 11803. Controlled circulation postage paid at Plainview, NY 11803 and an additional mailing office.

OUR BOTTOM LINE IS

Our bottom line of service means *your* bottom line will be more profitable.

Single Source.

The widest range of commercial sound products in the industry. Even hard-to-find items.

Fast Delivery.

Orders are shipped within 36 hours of receipt. Faster if necessary.

Sound Advice.

Personal attention, plus professional advice on any technical problems. We're your unseen partner.

50 Years' Experience.

Service and reliability that have been proven over the years. You can depend on us!

Call toll free today for new price list.

1-800-527-5705
TEXAS 1-800-442-1564

SERVICE

J. W. Davis & Company
3215 Canton Street
P.O. Box 26177
Dallas, Texas 75226



Letters

SEVEN WAVES HITS THE USA

In response to the myriad of letters requesting information on Suzanne Ciani's *Seven Waves* album (the subject of a feature by Howard Sherman in the July, 1982 db), we are pleased to announce that it has been taken under the distribution wing of NY-based Important Records. As of now, *Seven Waves* has been placed in record stores in New York, Atlanta, Houston and Chicago. For information on how to obtain the album in your area, contact Important Records, 149-03 New York Blvd., Jamaica, NY 11434. Tel: (212) 995-9200.

LONG-PLAYING VS MICRO-GROOVE

I would like to comment on your comments to the letter from F. G. Greenberg (about Rene Snepvangers—December, 1982, p. 6—Ed.).

First, his name was properly "Snepvangers" (Dutch). Second, there is, as always, a confusion between long-playing and "Micro-Groove®." The former refers only to the 33 $\frac{1}{3}$ rpm speed which has existed for a long time. "Micro-Groove" was an invention of CBS Labs, released in 1948.

I have RCA Records catalogues from 1934-1936, and these have a large section entitled "Long Playing Records," which were simply 33 $\frac{1}{3}$ rpm shellac standard-groove records with 2.34 times more music content. They were normally played on a motor similar to the one used on Neumann lathes prior to 1980. It was invented by the German Saja Company, and was simply a multiple synchronizer able to run in both directions, depending on the direction in which you started it.

The Micro-Groove part was added by a combination of CBS Labs and Fairchild, who developed the heated stylus feature that was so necessary to fidelity at the lower speed.

I believe it is a common practice everywhere to credit the head of a research lab for the work done by the lab. Rene Snepvangers undoubtedly did most of the work, while his boss took most of the credit. But it is fair to say that the success of any research lab is dependent to such a great extent on its organization and administration that its chief executive should get a large amount of the credit. That tradition certainly continued after the death of Dr. Goldmark, and is true today at many Japanese labs as well.

STEPHEN F. TEMMER
Gotham Audio Corporation
New York City

Index of Advertisers

| | |
|-----------------------------------|--------------|
| Amber | 15 |
| Ampex | Cover IV, 24 |
| Auditronics | 27 |
| Center for the Media Arts | 49 |
| Cetec Gauss | 19 |
| Eastman School of Music | 18 |
| Emilar | 17 |
| JBL | 9 |
| J. W. Davis | 6 |
| Kimball | 8 |
| Knowles | 36 |
| MCI/Sony | 21 |
| Midwest Acoustic Conference | 16 |
| Modular Audio Products | 49 |
| Nagra Magnetics | 15 |
| Otari | Cover II |
| PAIA | 18 |
| Polyfusion | 14 |
| Polyline | 17 |
| Protech Audio | 14 |
| Quad-Eight | 25 |
| QSC | 11 |
| Renkus-Heinz | 8 |
| Saki Magnetics | 12 |
| Shure Bros. | 23 |
| Solid State Logic | 34-35 |
| Sound Ideas | 20 |
| Standard Tape Labs | 56 |
| Studer Revox | 33 |
| Telex | 38 |
| Tentel | 57 |
| UREI | Cover III |

Coming Next Month

• In April, we will present an audio potpourri, covering everything from the acoustics of a California natatorium to the sound of an outdoor rock festival. Richard Hughes and Milton Johnson have teamed up to bring us an article on the sound system and acoustics of the Cerritos Natatorium, while David McLaughlin and Robert Bolles check in with a piece on SuperJam '82. In addition, we'll have a postscript on studio powering and grounding techniques and, of course, our regular lineup of columnists and departments. All this, and more, coming in April's db—The Sound Engineering Magazine.

Now your ENG units can afford the same "line" microphones bought by every major network!

You can pay as much as \$1,500 or more to get a good long-reach line microphone. Or, you can put the new Audio-Technica AT815 in every production unit for under \$230 each, or the phantom-powered AT815R for under \$300 each.

What you'll hear is performance closely rivalling our more expensive brethren. So close, in fact, that every major network has tried and bought our line microphones. And you'll get some advantages which can be very important in the field.

For instance, the phantom-powered AT815R can interface with supply voltages from 9 to 52 volts without adapters or extra circuits. So you don't have to rebuild present equipment to put it on the air. We also have a neat 2-battery 9V power supply you can use. When one battery is in use, the other is on standby. For your peace of mind.

Our internal-battery AT815 uses a standard AA "penlite" cell available everywhere. And in intermittent use, a premium battery should last about 4,000

hours. That's over a year even if used eight hours every day! Just one less thing to worry about when time is short.

The AT815 and AT815R weigh barely over 9 ounces, to make them easy to "fishpole" or hand hold. And each comes with a foam windscreen which slips on in a second. Our optional shock mount can be added as well. And the AT815R has a bass roll-off switch if needed to control rumble.

Both models are designed to take the rough-and-tumble life of an ENG unit or remote film crew, and keep delivering excellent sound. With the narrow directivity which makes line microphones so useful in suppressing noise and "reaching out" beyond normal mike range.

If you thought line microphones were out of reach of your budget, ask your Audio-Technica sound specialist to show you the AT815 or AT815R. We think you'll agree that the networks are onto something great!

**AT815R Phantom-Powered
Line + Gradient Microphone.
Under \$300.**

**AT815
Line + Gradient
Microphone.
Under \$230.
Optional
shock mount extra.**

**AT8410a Shock
Mount. Under \$40.**

**AT8501 9V Dual Battery
Power Supply. Under \$100.**



audio-technica®

AUDIO-TECHNICA U.S., INC., 1221 Commerce Dr., Stow, OH 44224 216/686-2600

Circle 19 on Reader Service Card

More and more recording studios are discovering the great sound of the Kimball Professional Grand.

Here's why:

The Kimball 6' 7" Professional Grand derives its heritage of greatness from the world's finest piano—the Bosendorfer. The scale and plate design are derived from the Bosendorfer Model 200, and the plate is extra thick to assure maximum sustain and to avoid plate noise from hammer strikes. The Bosendorfer-derived scale and non-duplexed trebles enhance tonal depth, clarity, and pitch perception. The Kimball Professional Grand is specifically designed for clear, pure tonality, free of spurious noise and false harmonics. It also offers superior durability and tuning stability. Its entire structure, including the soundboard, is of precision-laminated woods, greatly reducing differential expansion in changes of temperature and humidity.



For more information about the Kimball Professional Grand, contact Wade Bray at (812) 482-1600.



Circle 39 on Reader Service Card

It's **UN-BEAR-ABLE**

to know you haven't subscribed to db yet!



Our rate for new subscribers is only \$10.00 and a free sample is available upon request. See coupon on reader service card.

db replies:

Our thanks to Mr. Temmer and others who have contacted us about Mr. Snep-rangers' role in the development of the long-playing record, Micro-Groove or otherwise. We hope to have an interesting feature article soon about the early days of the lp, and would welcome any other inputs from our readers.

EXTENSIVE, YES— EXHAUSTIVE, NO

In the January New Literature department, we told you of a 120-page brochure available from Crown on the PZM[®] microphone. While the subject of the brochure is the PZM[®], and the brochure is by Crown, the length is *not* 120 pages—it is 12! Well, no one is perfect, as our proofreader constantly reminds us in both word and deed.

LINE LOSS FOUND

TO THE EDITOR:

John Eargle did a fine job in the January '83 issue of db explaining, in a simple and understandable way, the workings of a constant voltage distribution system for PA. In particular, I was impressed with his inclusion of the line loss that could be expected for given lengths of wire and wire gauges. I haven't verified his computations, but they seem to be reasonable.

Several years ago I was involved in the design and application of line matching transformers and, as might be expected, there are many grades and levels of performance. One attribute of a matching transformer is of great relevance to Mr. Eargle's analysis. That attribute is insertion loss! My experience has been that the loss can be anywhere from 1 dB to 6 dB. The typical ½ watt and 1 watt transformers at the time I was taking measurements—and I hope improvements in materials and winding techniques have been made in recent years—was 3 dB. The better grade (and more expensive ones) were about 1 dB. Moreover, I found that the manufacturer was not always consistent in his rating method. Take the case of the 1 watt transformer, for instance. While one unit would consume 2 watts from the line and deliver 1 watt to the speaker, the next unit, from another manufacturer, would consume 1 watt from the line but deliver only ½ watt to the speaker.

The system designer must weigh the cost of more amplifier power against the cost of purchasing the higher grade transformer with less loss. To compound matters, the transformer manufacturer rarely specifies what the loss factors are, leaving the engineer to his own devices.

Perhaps you could ask Mr. Eargle to consider a future article on how to measure transformer loss and how to factor it in when designing a distributive PA system.

ALMON CLEGG

Matsushita Electric Corp. of America

High Technology. JBL.

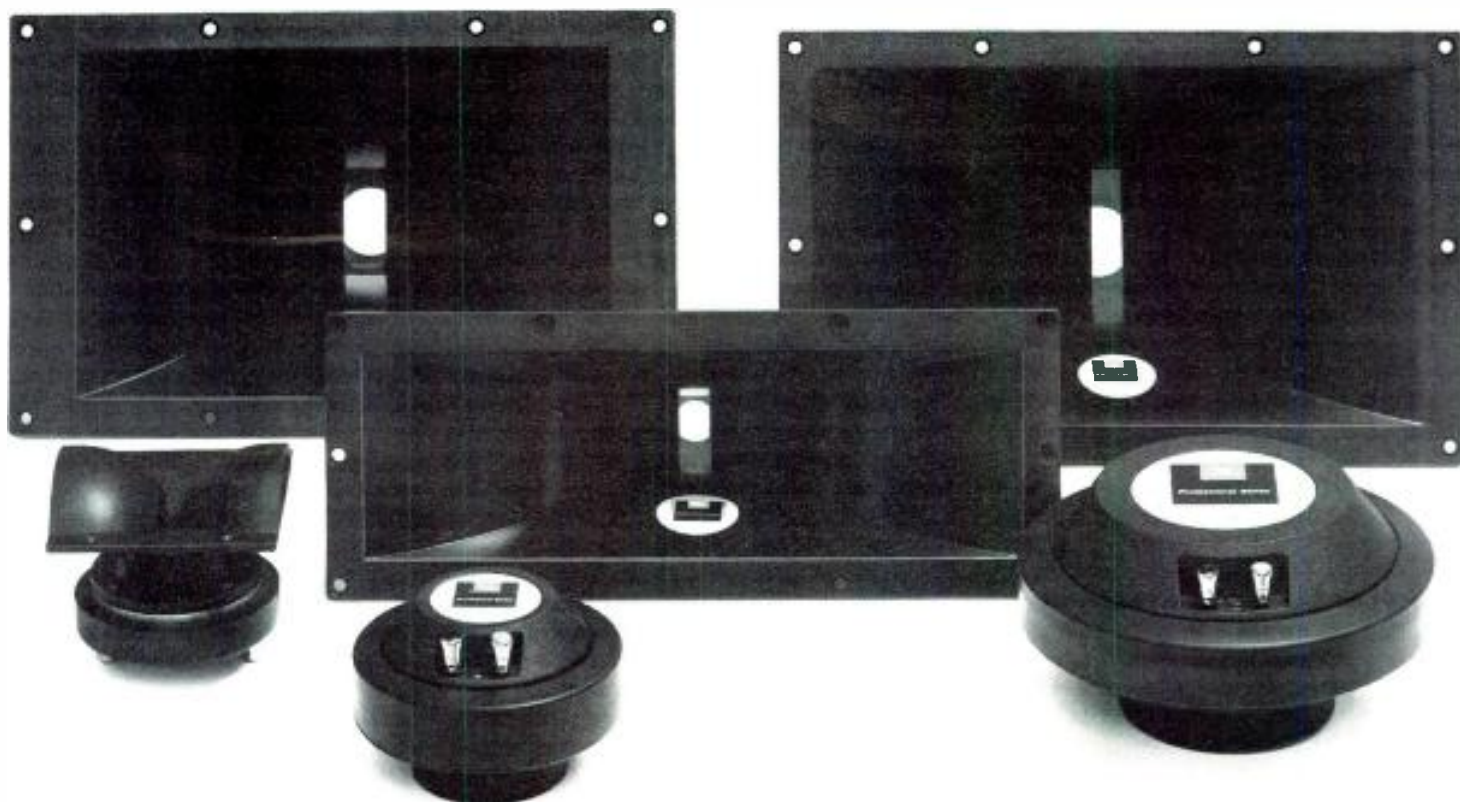

Until now, buying advanced technology high frequency components could be both a pleasure and a problem. A pleasure because of the improved performance these devices can provide. A problem because exotic designs can often be less than reliable. Or easy to use. Or cost effective.

At JBL, we don't think you should have to give up practicality to get the performance you need. And to prove it we're introducing a new generation of high frequency components that combine unsurpassed frequency response, high reliability, and surprisingly affordable prices.

The secret behind this rare blend of features lies in the use of new engineering technologies that not only improve performance, but actually reduce manufacturing costs.

Our latest 1- and 2-inch throat diameter compression drivers, for example, utilize a pure titanium diaphragm with JBL's patented diamond-pattern

surround. The exceptionally high stress limit of titanium together with the stronger surround allows this design to match the reliability of phenolic and composite type diaphragms. At the same time, the design's improved



JBL's titanium-diamond diaphragm combines performance with reliability.

flexibility and light weight provide the extended frequency response of more expensive, fragile, exotic metal diaphragms. Finally, the drivers feature a newly developed, high-flux ferrite magnetic structure for maximum efficiency and extended response.

And the drivers are only part of the story. Because JBL engineers have also developed a complete new line of compact,

Bi-Radial™ constant coverage horns. Designed for flush cabinet mounting or compact cluster applications, the horns provide precise pattern control. The horn's highly consistent horizontal dispersion eliminates the problems of midrange narrowing and high frequency beaming associated with conventional horn designs.

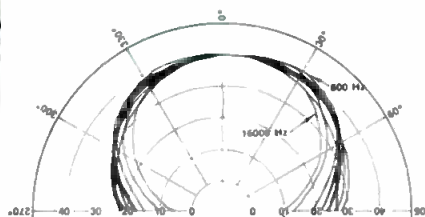

Composite 1/2-octave polar responses of a 2380 horn from 800 Hz - 16 kHz in the horizontal plane.

So if you're looking for advanced high frequency components that combine real world practicality with unmatched performance, ask your local dealer about the new generation of high technology. From JBL.



**Professional
Products
Division**

JBL/harman international

JBL Incorporated,
8500 Balboa Boulevard, P.O. Box 2200,
Northridge, California 91329 U.S.A.

Circle 38 on Reader Service Card

www.americanradiohistory.com

SPARS Meets Students

• Everyone in the audio industry has their own story about how they started in the business. For many professionals, the path to success most likely started at the proverbial bottom of the ladder. Most top recording engineers, for example, probably spent long years buying the beer and bending goose-necks into bass drums. That kind of apprenticeship has always been mandatory in the recording business. Perhaps because of the small number of positions available in studios, there has historically been little opportunity to learn the trade elsewhere. Education, primarily through short courses, has only incompletely trained prospective employees, while higher education has ignored the need entirely. Only an occasional electrical engineering graduate has made the transition from workbench to console. In general, the only way to get started in the business was to hang around the studio and let persistence and fate do what they may.

CHANGES FOR THE BETTER

Of course, this scenario has changed dramatically over the past few years. For some totally explainable reason, the recording business came to be perceived as a tremendously glamorous profession. Apparently the business failed to maintain secrecy, and let slip the fact that producers are all close personal friends of Mick Jagger, and that all recording engineers only work one or two weeks a year, during which time they leave their houses in Malibu and go into the city to mix another gold record. Whatever the reason, interest in the profession exploded along with record sales in the 70s and the demand for instruction reached even to the heights of academia. The scope of training workshops increased and accredited institutions stepped in to fill the need.

First in line, and one that actually anticipated the demand (rather than reacted to it), was the School of Music at

the University of Miami. The School instituted a four year degree program in Music Engineering Technology, culminating in a Bachelor's degree in Music, with a minor in Electrical Engineering. Conceived by Dr. Ted Crager, the program was devised to teach more aesthetics than a technical degree, and teach more technology than a music or tonmeister degree. Starting with the premise that in recording *nothing* is relevant without the music, each applicant to the program is first auditioned for musical ability. After admission (only the best are taken from a long waiting list), subjects such as music theory, arranging, orchestration, conducting, principle instrument, ensemble work, calculus, circuit theory, acoustic design, recording techniques, and digital audio recording comprise the four year curriculum. In addition, each student accomplishes hundreds of hours of recording and remix time in the school's MCI-equipped 24-track room. Thus the School is a training ground for 80 select students who have come to college to learn about music engineering—and enter the profession. It is curious to note that in the past, many individuals entered the audio business because an opportunity to attend college wasn't available, whereas today young people attend college specifically to enter the business. That alone speaks for the change which is occurring in the industry.

SPARS GOES BACK TO SCHOOL

On the opposite end of the ladder is the Society of Professional Audio Recording Studios (SPARS), a collection of the top studios in the country. Their membership, including such studios as Universal, United Western, Sound Works, JVC Cutting Center, Alpha Audio, Motown, Criteria, Editel, Fanta, Record Plant, and Sigma Sound, accounts for so many gold records that if they were laid end to end

they would stretch across every record company's bottom line. These studios organized to bring some unity to that badly fragmented aspect of the industry in which cutthroat tactics have promoted widespread price-cutting and even more widespread quality-cutting. In a post-boom era when the consumer has become keenly aware of the technical quality of the recordings he purchases, these studio owners and operators recognized that the industry's product was being damaged by inferior recordings. Similarly, they perceived great inequities in the skills employed in recording studios; in the light of the growing sophistication of recording hardware and techniques, they questioned the traditional transition from go-fer to engineer. Thus the SPARS members speculated that perhaps more rigorous standards could be applied to both recording practices and studio hiring. With these and other questions in the balance, the two ends of the ladder recently came together in Miami.

Following their board of governor's meeting at Mack Emerman's Criteria Studios, the SPARS members organized a seminar on Education in Audio for the students at the University of Miami. To learn more about their future employers (and to cut a day of classes), the music engineering students welcomed the SPARS members. The seminar opened with a morning forum discussion between Murray Allen, Jerry Barnes, Bob Walters, Charlie Benanty and the student body. Diverging topics retained the thread of the question—what do studio owners look for in an employee? Answers touched on the qualifications required of any employee for any job—reliable, knowledgeable, mature, hard-working—but emphasized a studio's specific needs in terms of audio ability. The employers clearly recognized that only an exceptional person is suited for the frustrations and challenges of the job.

Suddenly, everyone else has to start over.

PASSIVE COOLING
No fan noises. No internal dust build-up.

FRONT REMOVABLE CHANNEL MODULES
All electronics for each channel can be exchanged while amp is in rack.

HIGH POWER/LOW PROFILE DESIGN
Using high efficiency output circuits for cool, high reliability operation.

CENTRAL WELDED STEEL AC AND TRANSFORMER BAY
For maximum strength and shielding.

FLOATING INTERNAL CONNECTOR SYSTEM
Prevents contact damage from road vibration. All gold contacts in signal level path.

TRUE DUAL MONO CONFIGURATION
Two completely separate amps only sharing common AC cord for maximum reliability and flexibility. All protection separate for each channel.

HIGH DYNAMIC HEADROOM AND MULTIPLE PARALLEL, LOW ESR FILTER CAPACITORS
Provides exceptionally tight, high-impact bass performance.

COMPREHENSIVE INTERFACE PANEL
Includes 1/4" RTS, XLR, and barrier inputs. Provision for active or passive accessory input modules such as crossovers, filters, limiters, and transformers. Binding and barrier outputs provided.

REINFORCED FRONT AND REAR RACK MOUNTS.



OVER-TEMP WARNING LIGHT
Begins flashing 10°C before thermal protect.

LEVEL INDICATORS
To monitor output.

SEPARATE AC SWITCHES
Enable single channel to be powered up or down. Useful for emergency speaker changes during performance.

RECESSED CONTROLS
Prevent damage and accidental movement.

PRECISION 31-STEP DETENTED GAIN CONTROL
Gold plated wiper and sealed body design assures accuracy and freedom from sonic degradation.

CLIP INDICATOR
Flashes during all types of distortion.

POWER/PROTECT INDICATORS
Monitor status of Load Grounding™ protection relays. Relays provide delayed turn-on, instant turn-off, DC, sub-audio, power interrupt, and over-temp protection.

FRONT MOUNTED CIRCUIT BREAKERS
No tumbling around in the back of the rack.

MASSIVE OUTPUT SEMI-CONDUCTOR SECTION
Assures long-term reliability under abusive conditions.

Series Three from QSC. From this point on, every other power amplifier takes a step backward.

We've designed what will be the standard from which everything else is measured.

Series Three combines high-performance, reliability, and microscopic attention to detail, design and the execution thereof.

Our overall goal was to provide a series of reference-quality professional amplifiers designed specifically for major studios, touring companies and engineered sound installations.

We met our goal. As a matter of fact, we significantly exceeded it.

Take a look at the features of our Series Three amplifiers. High-efficiency circuitry, extended dynamic headroom, true dual-mono configuration, front-removable modular design. And we've packaged it all in a low-profile chassis. More power, less rack space. We were so impressed with our prototype Series Three amps that

we decided to take them into the field for numerous "A/B" listening comparisons. They were compared for audio quality and performance under a wide range of power requirement conditions. As we had expected, the response was overwhelmingly positive. The Series Three amplifiers stood a significant step above the others.

The moral of the story: Why settle for a product that's only outstanding in a few areas? QSC Series Three is a comprehensive design approach that combines exceptional audio performance, solid reliability, state-of-the-art features, and more power in less rack space.

So we urge you to look into our Series Three amplifiers. Because while everybody else is looking where they've been, QSC is stepping into the future.

QSC Audio Products, 1926 Placentia Avenue, Costa Mesa, CA 92627. Phone: (714) 645-2540.

QSC
AUDIO

CANADA: SF MARKETING, INC. • 312 Benjamin Hudon, Montreal, Quebec • Canada H4N1J4
INTERNATIONAL: E AND E INSTRUMENTS INTERNATIONAL, INC. • 23011 Moulton Parkway, Building F7 • Laguna Hills, CA 92653

Circle 28 on Reader Service Card
www.americanradiohistory.com

Thus they are concerned primarily with their own intuitive methods of appraising job candidates, using methods ranging from the legibility of their handwriting, to their interpersonal dealings, to their session experience. They stressed that it is apparently impossible to immediately evaluate an applicant; rather a more lengthy procedure of breaking-in and observation of work attitudes is necessary. Also, one's past experience provides clues to aid the judgment.

The question of experience is the paradox familiar to anyone seeking an entry level position. Every employer says—sorry, we can't hire you, you don't have any experience; to that dilemma, the SPARS members stressed that the need to start at the bottom is seldom changed by the fact of education alone. The inevitable question arose—why then should students attend school for four years when they could start at the bottom and gain four years of work experience? The answer, of course, is that *education* is an important prerequisite to *learning*. And, in today's studio environment, that adage is even more demonstrable. The steadily-encroaching technology tide now guarantees that only the most knowledgeable and best prepared individuals will have any chance of long-term success.

The mid-morning session offered

SPARS members the opportunity to exercise their professional expertise. Sessions were held on audio for video (Murray Allen, Len Pearlman), the business side of recording (Nick Colleran, Dave Teig, Chris Stone), mixing techniques (Mack Emerman, Joe Tar-



Lou Dollenger (Mitsubishi), Tore Nordahl (Neve) and John Carey (Otari), presenting a manufacturer's eye-view of the industry.

sia), remote recording (Johnny Rosen), disc cutting (Larry Boden), and digital audio (Charles Benanty). Most experienced and knowledgeable people take pleasure in communicating their understanding, and the impromptu SPARS professors proved to be no exceptions; they attacked their duties with real ambition. Likewise the

students were released from the old, tired jokes of their regular teachers and enjoyed the new, tired jokes of the SPARS members. Heated discussion topics ranged from apparent loudness in mixing to the console of the future, from microphone techniques to curvature overload, from ground-lift switches to dither. While the SPARS members clearly know absolutely everything there is to know about audio, it is safe to say that the students reawakened some old perceptions and cast new light on several certainties. As Mack Emerman summarized his session on mixing techniques: "We got into a heavy discussion about apparent loudness—it's something I do all the time, but I haven't thought about it for years." Perhaps more than any other aspect of the day-long seminar, that alone expresses the benefit of such a seminar—each end of the ladder stimulates something in the other. The students were perhaps shocked to learn that their art is also a business, but the SPARS members were likewise surprised to remember that their business entails an art. Therein is the beauty of experience meeting with inexperience. It is a quality which teachers are rewarded with daily and moreover something which every professional practitioner should constantly access in his working philosophy.

THE MANUFACTURERS JOIN IN

The first afternoon session brought another perspective to the proceedings. Manufacturers had been invited to send representatives to the School to participate in discussions concerning the manufacturer's role in meeting the industry's needs, and the kind of education needed to master their products. It was interesting to note that with the partial exception of MCI/Sony, only foreign-based companies responded to the invitation. It was speculated that perhaps this was another example of the inability of American companies to communicate with the domestic industry. The representatives in attendance were Doug Dickey (Solid State Logic), Lou Dollenger (Mitsubishi), John Carey (Otari), Tore Nordahl (Neve), and Lutz Meyer (MCI/Sony).

Following presentations by the representatives, discussion centered around the role of corporations in interacting with the concerns of the practicing industry and specifically with the educational process. Representatives were asked to detail their company's involvement with education, and several responded with information on apprentice programs. Further discussion revealed that concrete support of educational institutions was apparently lacking in most cases; John Monforte, lecturer at the School, noted that MCI/Sony had been an outstanding exception to the rule with its past

IN STOCK!

**Saki heads are
the finest in
the industry.
Every head is
dynamically
tested and
unconditionally**

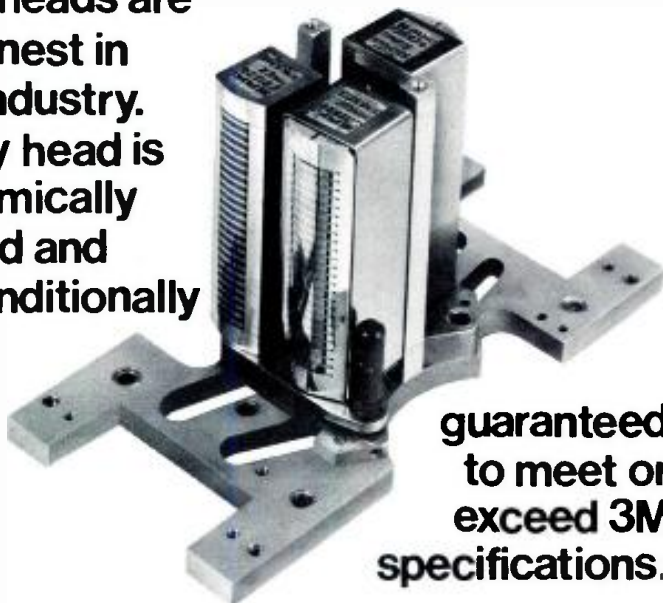

**guaranteed
to meet or
exceed 3M
specifications.**



SAKI MAGNETICS, INC.

A CALIFORNIA CORPORATION

8650 Hayden Place, Culver City, CA 90230 213 / 559-6704 (TWX-910-328-6100)

Circle 21 on Reader Service Card

www.americanradiohistory.com

Updated Recording Studio Handbook

A must for every working
professional... student...
audio enthusiast

Features latest state-of-the art
technology of creative sound recording.

21 Fact-Filled Chapters

- I. The Basics**
 - 1. The Decibel
 - 2. Sound
- II. Transducers: Microphones and Loudspeakers**
 - 3. Microphone Design
 - 4. Microphone Technique
 - 5. Loudspeakers
- III. Signal Processing Devices**
 - 6. Echo and Reverberation
 - 7. Equalizers
 - 8. Compressors, Limiters and Expanders
 - 9. Flanging and Phasing
- IV. Magnetic Recording**
 - 10. Tape and Tape Recorder Fundamentals
 - 11. Magnetic Recording Tape
 - 12. The Tape Recorder
- V. Noise and Noise Reduction**
 - 13. Tape Recorder Alignment
 - 14. Noise and Noise Reduction Principles
- 15. Studio Noise Reduction Systems
- VI. Recording Consoles**
 - 16. The Modern Recording Studio Console
- VII. Recording Techniques**
 - 17. The Recording Session
 - 18. The Mixdown Session
- Three all-new Chapters**
 - 19. The In-Line Recording Studio Console (The I/O Module, The Basic In-line Recording Console, Signal flow details)
 - 20. An Introduction to Digital Audio (Digital Design Basics, Digital Recording and Playback, Error Detection and Correction, Editing Digital Tapes)
 - 21. Time Code Implementation (The SMPTE Time Code, Time-Code Structure, Time-Code Hardware.)



\$39.50

Easy to Order

You can enclose a check with your order or charge it to Master Charge or BankAmericard/Visa. Use the coupon below to order your copies of the new updated *Recording Studio Handbook* (\$39.50).

ELAR PUBLISHING COMPANY, INC.

1120 Old Country Road, Plainview, N.Y. 11803

Yes! Please send _____ copies of THE RECORDING STUDIO HANDBOOK. \$39.50. On 15-day approval.

Name _____

Address _____

City/State/Zip _____

Total payment enclosed \$ _____
(In N.Y.S. add appropriate sales tax)

Please charge my Master Charge
 BankAmericard/Visa

Account # _____ Exp. date _____

Signature _____

(changes not valid unless signed)

Outside U.S.A. add \$2.00 for postage.

Checks must be in U.S. funds drawn on a U.S. bank.

The *Recording Studio Handbook* is an indispensable guide with something in it for everybody. It covers the basics beautifully. It provides in-depth insight into common situations and problems encountered by the professional engineer. It offers clear, practical explanations on a proliferation of new devices. **And now it has been expanded with three all-new chapters . . . chapters on the in-line recording studio console, digital audio and time code implementation.**

Sixth printing of industry's "first" complete handbook

The *Recording Studio Handbook* has been so widely read that we've had to go into a sixth printing to keep up with demand (over 30,000 copies now in print). Because it contains a wealth of data on every major facet of recording technology, it is invaluable for anyone interested in the current state of the recording art. (It has been selected as a textbook by several universities for their audio training program.)

Highly Acclaimed

Naturally, we love our book. But don't take our word for it. Here's what others have to say.

"John Woram has filled a gaping hole in the audio literature. This is a very fine book . . . I recommend it highly." *High Fidelity*

"A very useful guide for anyone seriously concerned with the magnetic recording of sound." *Journal of the Audio Engineering Society*

15-Day Money-Back Guarantee

When you order *The Recording Studio Handbook* there's absolutely no risk involved. Check it out for 15 days. If you decide it doesn't measure up to your expectations, simply send it back and we'll gladly refund your money.

VCA—the easy way for superior audio systems control



consolidate
control in broadcast, satellite,
production/recording audio systems

All the flexibility of modular design, All the convenience of rack equipment. The ProTech Model 668VCA is 2, 3, or 4 channels of VCA control with integral power supply. Available with or without output transformers. Increase Profits & Reliability. Call or Write Today—

ProTech™ (516) 584-5855
Audio Flowerfield Bldg #1
St. James, N.Y. 11780

Circle 18 on Reader Service Card

PRO-GRAPH PROGRAMMABLE GRAPHIC EQUALIZER



- 64 PROGRAM MEMORY CAPACITY
- 105dB GUARANTEED S/N
- REMOTE CONTROLLABLE
- 16 BANDS @ 2/3 OCTAVE SPACING
- BALANCED INPUTS & OUTPUTS
- VARIABLE INTENSITY SCREEN
- ±14dB CUT & BOOST RANGE
- MASTER/SLAVE LINKABLE

Design response curves, store them in memory, recall and display them instantly with precise repeatability--and all at the touch of a button. Free color brochure upon request.

polyfusion INC.

92 Benbro Drive
Buffalo, NY 14225
(716) 681-3040

PRO-GRAPH CAN BE SEEN IN BOOTH #422

Circle 14 on Reader Service Card

www.americanradiohistory.com

support of the University of Miami.

In the continuing discussion, SPARS members pointed out examples of where the manufacturing sector of the industry had abandoned its proper role of serving the user's needs; owners called for more rapport between users and manufacturers. Similar debate raged over the question of the high cost of technology. Some studio owners felt that they were being priced out of the business, and feared the creation of a monolithic structure of the studio trade in which only a few facilities could afford to maintain state of the art. In defense of the manufacturing industry, Lutz Meyer patiently explained ongoing efforts to design down the cost of hardware and increase its cost effectiveness by taking advantage of new technology such as the microprocessor. It was shown that many price increases are due to component price increases, and that the manufacturer's profit margin has decreased in some cases due to increased competition.

The final session of the day was an attempt to summarize the highlights of the previous sessions, and give an opportunity for questions. The discussion turned naturally toward questions of perception between students and studios. Students wanted to know how they would be perceived as college graduates looking for work in an industry where academic credentials traditionally have meant little. They were anxious to dispel the myth that such graduates would ex post facto lack any real-world sense; they wanted a chance to demonstrate the advantages of their limited yet solidly-based hands-on experience and show that their training would accelerate their assimilation into studio operation as productive employees. And owners were complementarily eager to refute the belief that every studio insists on taking on only dirt-ignorant people because they must somehow train them in their own special way from the ground up; they denied the notion that the top studios shy away from college-educated people because such individuals must be deprogrammed from their bad "book-learned" habits. Eventually, both owners and students agreed that professionalism can be trained for in school, and finally achieved in the studio. Owners encouraged the learning and refinement of skills in school and speculated that better education could only evolve into more professionalism in the audio industry. The seminar concluded with mutual admiration, and applause.

I don't have to add much in summary. When the bottom of the ladder talks with the top, it helps everyone; the top better understands the nature of its support, and the bottom better perceives its way upward. In that sense it all boils down to education; we all have something to learn. ■

Looking for a Distortion Analyser?

Check the little guy
on the right...



1710A

339A

3501

... the highest performance, most featured and easiest to use audio distortion and noise measurement system in the industry. (and at the lowest price)

amber

Amber Electro Design Ltd.
4810 Jean Talon West
Montreal Canada H4P 2N5
Telephone (514) 735 4105

Circle 20 on Reader Service Card

| | Sound Technology 1710A | Hewlett Packard 339A | Amber 3501 |
|-------------------------------|------------------------------|----------------------------|---------------|
| Balanced Input & Output | YES | NO | YES* |
| Termination Switches | NO | NO | YES |
| IMD: SMPTE/DIN | YES* | NO | YES* |
| CCIF/IHF | NO | NO | YES* |
| Frequency Range | 7kHz fixed | — | 2kHz-100kHz |
| Automatic Set Level | YES | YES | YES |
| Automatic Null | YES | YES | YES |
| Quantity of Filters | 3 | 3 | 4 |
| Filters user changeable | NO | NO | YES |
| Continuous frequency tuning | NO | NO | YES |
| Calibrated output attenuator | YES | YES | YES |
| Selective voltmeter mode | NO | NO | YES |
| Battery operation | NO | NO | Option |
| Options field installable | NO | NO | YES |
| Residual distortion 1kHz | <0.002% | <0.0018% | <0.0008% |
| 100kHz | <0.35% | <0.032% | <0.006% |
| Residual noise (80kHz BW) | <8µV | <8µV | <2µV |
| Maximum output (600 ohm load) | +26dBm | +12dBm | +28dBm |
| Minimum input THD mode | -18dBm | -28dBm | -28dBm |
| Auto-null time | <6 secs | not spec | <2 secs |
| Voltmeter sensitivity (F.S.) | -80dBm | -80dBm* | -120dBm |
| Size (cubic feet) | 1.6 | 1.0 | 0.4 |
| Weight (pounds) | 25 | 18 | 12.5 |
| Price (unbalanced) | — | \$2700* | \$2100 |
| balanced | \$4195 | — | \$2850* |
| balanced + IMD | \$5195* | — | \$3550* |

*certain features are options and are included in price stated.



**T-Audio by Nagra won't make audio production easy.
Just better.**

The revolutionary T-Audio two-track recorder by Nagra features a totally isolated transport system with twin capstans and servo-controlled motors with interhead tape tension sensors, as well as the kind of performance you'd expect from Nagra. Available with Time Code and features you won't find on any other machine. For more details about this extraordinary recorder,

write to Nagra Magnetic Recorders, Inc., 19 West
44th Street, Room 715, New York, N.Y. 10036 (212) 840-0999.
1147 N. Vine St., Hollywood, Ca. 90038 (213) 469-6391

NAGRA KUDELSKI

A PASSION FOR PERFECTION

Digital Audio

Transmission and Distribution

DISTRIBUTION

Now that we are finished with the topic of digital filters, let us turn back to an older topic which we have not discussed in depth: transmission and distribution of digital audio. Much of the original discussion assumed a 16-bit word which was shipped from place to place in a parallel format. When the 16 data bits were communicated from a source to a destination, they were sent via 16 individual channels. Although such a channel is conceptually as simple as 16 wires or 16 twisted wire-pairs, it is very impractical in many applications.

To illustrate the difficulty, consider a large studio complex made up of a large amount of digital equipment. Consider that one digital tape recorder must have the ability to be fed from any of 25 different digital signal sources. This would require a multiplex selector which could connect the 16 data wires to any of 25 sets of 16 data wires.

Conceptually simple, practically impossible! There would be about 900 wires just for this function if one used twisted pair. The parallel approach, with all the bits of data word present simultaneously, is only appropriate within a piece of equipment.

The alternative is to multiplex all 16 bits in a serial bit stream. Now, a single twisted pair can handle all of the data bits, if the bit rate is 16 times higher. The 16:1 reduction in wires is a major issue. This same issue is being addressed in new commercial airliners, because the weight of the wiring is approaching the ton level. Communications in ships also has the same problem. With a serial mode of communications one can not only place all 16 bits on one wire, but one can also place many sets of 16 bits on the wire. Each set occupies its own time slot. Selection of the source is thus only a matter of selecting which set of 16 bits

is desired. The limit is only a matter of the frequency capacity of the wire.

With coaxial cable and special digital line drivers and receivers, one can transmit data at about 10 Mbit-per-second over several hundred feet. This would allow between 8 and 12 audio channels to be placed on a single-wire system. Notice how much simpler the wiring would be in this case. The cost of such an approach is that one needs a special interface box to connect between the equipment and the line. The interface is required to select and drive the particular audio channel's bits in the full data stream. However, electronic interface equipment can be made much cheaper than the cost of union electricians' hand wiring of large installations. In a modern office computer facility, the cost of wiring can become a large portion of the total installation cost. The same would be true for the digital audio broadcast



MAC - 83 AUDIO SIGNAL PROCESSING

Saturday, April 23, 1983
Hermann Hall
Illinois Institute of Technology
Chicago, Illinois

- ⚡ **Recording – Playback**
- ⚡ **Measurement – Instrumentation**
- ⚡ **Speech Generation – Recognition**
- ⚡ **Telecommunications**
- ⚡ **Hearing Improvement**
- ⚡ **Music – Sound Generation**

house or recording studio. Unfortunately, the subject of interface becomes very complex very quickly unless one looks at the problems carefully.



Figure 1. How many ones and zeroes are in this bit sequence?

CLOCKING

If we are to place all the data bits on one wire, we need a way to tell when one bit ends and the next one begins. Consider the bit sequence of FIGURE 1. Is that four 1s followed by two 0s, or eight 1s followed by four 0s? We need a clock to tell where the bits are. A similar type question concerns the difference between 15 1s and 16 1s. Unless we have an absolute clock time reference, we cannot make the judgment.

An obvious way to have a clock is to have a second wire which accompanies the data, called the clock wire. However, since our goal is to avoid excessive wires, it would be nice if the clock could be recovered from the data wire itself. Any code which allows the clock to be recovered is called a Self-Clocking Code.

Before continuing, we need to explore the notion of codes, or modulation codes. Our data is in the form of 1s and 0s which we assume to be H (for high voltage) and L (for low voltage), since these are the TTL definitions. This kind of mapping or coding is direct and there is a simple relationship between H and L. We could, however, have defined a different kind of relationship where a 1 corresponds to a sineburst of 100 kHz and a 0 corresponds to a sineburst of 150 kHz. This mapping is called frequency-shift keying, or FSK. A modulation code is the symbol system used to define the logical 1 and 0. Some modulation codes are implicitly self-clocking, while others are not.

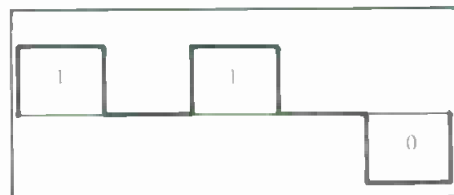

Figure 2. A self-clocking code.

The simplest self-clocking code is the Return-to-Zero (RZ) code shown in FIGURE 2, with the data pattern 110. It is a tri-valued code which returns to the zero value in between each bit, regardless of the value of the bit. A positive value signifies a 1 and a negative value signifies a 0. It is self-clocking because each bit is observable regardless of the number of similar bits. In one sense,

this bit stream has twice the number of bits in the sequence except that every other bit is a dummy. We can think of the bit stream in this example as 1A1A0A where the A is the defined zero value between bits. It is like punctuation which separates each piece of information. There are several problems with this type of code and it is almost never used in applications which have a high data rate. It wastes half of the signal bandwidth because of the dummy punctuation symbol A.

We are now in a position to understand one of the interesting issues for self-clocking codes: How much must the bit rate be reduced to incorporate the self-clocking feature? This question relates to the concept of a maximum bandwidth for the channel. If we had a channel with a bandwidth limitation of 10 MHz, then the direct coding of FIGURE 1 could apply a bit rate of 20 Mbits/sec, whereas the RZ of FIGURE 2 could only apply 10 Mbit/sec. The direct coding is called NRZ (non-return-to-zero). The extra return to zero does produce a major cost in bandwidth. The highest frequency of the NRZ code is a sequence of alternating 1s and 0s; whereas, the worst case for the RZ is a sequence of 1s or a sequence of 0s.

All other self-clocking codes fall someplace in between the above limits. The closer the code is to NRZ, the better it is in terms of data rate. The newer fancy codes can do even better than the classical reference, but that subject will be deferred.

The most classical self-clocking codes come under a variety of names such as Frequency Modulation (FM), BiPhase-M, Phase Encoding (PE), Manchester Code, etc. All of these have a similar definition:

- 1) Information is represented by a transition in the middle of the bit cell. The information is either the presence or absence of a transition in the cell center or in the direction of transition.
- 2) A transition between cells is taken as an artifact of the bit sequence and serves to restore the state for the next cell.

FIGURE 3 illustrates this process for PE coding with the sequence 1101. In the middle of the first cell, this is an up transition giving a binary 1 value. The middle of the next cell also has an up transition since it also has a 1 value. Notice that the boundary between the first and second cell had to have a down

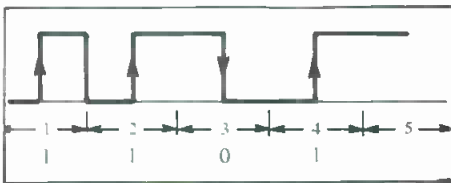

Figure 3. An example of phase encoding the four-bit digital word, 1101.

Audio Tape

for professionals

REEL TO REEL TAPE
Ampex, 3M. All grades.
On reels or hubs.

CASSETTES, C-10—C-90
With Agfa, TDK tape.

LEADER & SPLICING TAPE

EMPTY REELS & BOXES
All widths, sizes.

Competitive!
Shipped from Stock!

Ask for our recording supplies catalog.

Polyline Corp. 312/298-5300
1233 Rand Rd. • Des Plaines, IL 60016

Circle 40 on Reader Service Card

EL-15 Woofer

- 25-5000 Hz
- 200 Watts
- 100 dB M/W
- 4" Voice Coil

EMILAR

For complete information:
(714) 632-8500
(800) 854-7181
EMILAR CORPORATION
1365 N. McCan St.,
Anaheim, CA 92806

Circle 42 on Reader Service Card

Eastman Recording Institutes

Eastman School of Music of the University of Rochester

at modern, professional facilities

Basic Recording Techniques
June 27-August 5
Advanced Recording Techniques
July 18-August 5

Instruction by leading professionals in the fields of audio engineering: basic electronics as applied to audio engineering, acoustics, microphones, tape and disk recording equipment, studio recording, remotes, classical recording, signal processing, maintenance, etc. Labs, recording sessions, mixdowns. *Credit and non-credit*

Coordinator: Ros Ritchie, director of Eastman Recording Services

For information and applications, write: Summer Recording Institutes, Dept. N, Eastman School of Music, 26 Gibbs St., Rochester, NY 14604

The Eastman School of Music of the University of Rochester provides equal opportunity

Circle 29 on Reader Service Card



In general, spring reverbs don't have the best reputation in the world. Their bassy "twang" is only a rough approximation of natural room acoustics. That's a pity because it means that many people will dismiss this exceptional product as "just another spring reverb". And it's not. In this extraordinary design Craig Anderton uses double springs, but much more importantly "hot rod's" the transducers so that the muddy sound typical of most springs is replaced with the bright clarity associated with expensive studio plate systems.

Kit consists of circuit board, instructions, all electronic parts and two reverb spring units. User must provide power (± 9 to 15 v) and mounting (reverb units are typically mounted away from the console).

CHARGE TO VISA OR MC TOLL-FREE

1-800-654-8657 9AM to 5PM CST MON-FRI

DIRECT INQUIRIES TO:

RAI Electronics, Inc.

Dept. 3C, 1020 W. Wilshire Dr. Oklahoma City, OK 73116 (405) 843-9626

Send the 6740 REVERB KIT \$59.95 plus shipping (\$3) enclosed or charged.

Send Free Catalog

name _____

address _____

city _____ state _____ zip _____

Circle 30 on Reader Service Card

transition in order to allow for the next up transition. The boundary between the second and third bit cells does not need a transition because the third cell has a 0 which is a downward transition. Since the signal is already high, the downward direction is possible. Similarly, there is no extra transition between the third and fourth cells because the signal already has the right state to make the required transition.

In general, an alternating sequence of 1s and 0s produces the fewest number of transitions; a continuous sequence of 1s and 0s produces the largest number of transitions.

This type of code can be changed slightly to create Modified Frequency Modulation (MFM) which is also called the Delay Modulation and Miller Code (not Miller², which is different). The rules for this code are as follows:

- 1) The information for a logical 1 is represented by a transition in *either* direction in the center of the bit cell.
- 2) The information for a logical 0 is represented by no transition in the center of the bit cell.
- 3) In order to avoid long constant intervals with successive 0s, there is a transition at the cell boundaries for multiple 0s.

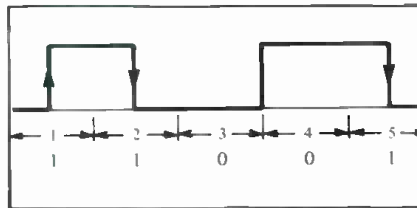

Figure 4. An example of MFM (Modified Frequency Modulation) encoding.

An example is shown in FIGURE 4 for the sequence 11001. There are transitions in the center of the first and second cells to indicate the 1s. There are no transitions in the center of the third and fourth cells to indicate the 0s; however, there is a transition *between* the third and fourth cell corresponding to rule 3 above. Finally, there is a

transition in the center of the fifth cell for the final 1. If we compare this MFM code with the previous PE code, we note that the frequency transition rate may be half that of the previous. There is never more than one transition per cell in the MFM, whereas there can be two transitions per cell in the PE code. Because the spectrum contains less high frequencies, this code can achieve the same bit rate as the original NRZ code discussed earlier. However, self-clocking is more difficult.

SELF-CLOCKING

We have talked about self-clocking as if it were obvious how one clocks these codes. In fact, it is not always obvious nor is it always easy to create self-clocking. To appreciate some of the subtleties, consider the MFM code just described with an infinite sequence of 1s. Now consider the same code with an infinite sequence of 0s. The result is identical! The MFM code has the property that there will be a transition at an interval corresponding to the bit cell length, or to 1.5 times the bit cell length. However, when there is a transition at the bit cell boundary, there is no information about it being at the centers or at the edges. We can tell when it has changed by the fact that there will be an interval that is longer; however, there is no absolute reference.

Self-clocking usually presumes some kind of initialization at a periodic interval, or it assumes some kind of error correction which can deal with the absolute reference issues. Once these systems synchronize or lock-up, they stay locked up quite well. In the typical application, the main clock references are crystals. This means that the receiver can rely on the fact that the clock is not changing rapidly and it need only keep track of small changes. In the typical application, a low-bandwidth phase-locked loop is used. Consider a phase-locked loop running at twice the clock frequency. It will produce an edge at both the center and the edge of each bit cell. When the

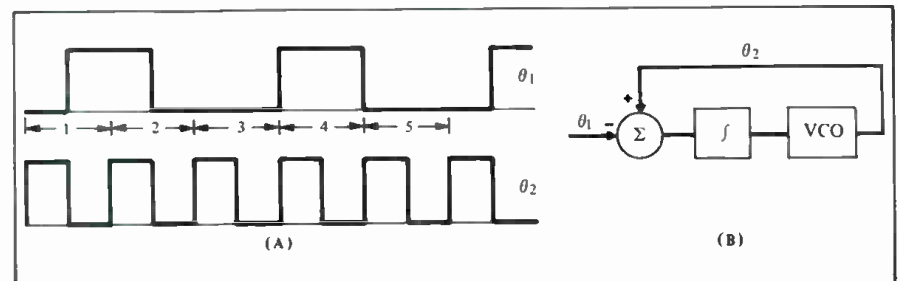

Figure 5. An example of the regeneration of clocks. θ_1 = incoming signal, θ_2 = regenerated clock, Σ = phase comparator which compares edges.

incoming signal produces a transition, it will be almost identical to the center or edge transition of the local regeneration clock from the phase-locked loop. It is unambiguous if the transition belongs to the center or the edge. The small errors can be used to either speed up or slow down the phase-locked loop.

FIGURE 5 illustrates the process. The top graph is the incoming data with transitions at either the center or the edge of the bit cell. The next graph is the regenerated clock running at twice the frequency. When the incoming data makes a transition, the time for this transition is compared to that of the regenerated local clock. If the local clock's transition is slightly early, meaning that the local oscillator is running too fast, then this information is used to slow the clock down. The reverse is true if the local oscillator is late. At each data transition there will be generated an error signal, e , which can be used to correct the local oscillator.

The block diagram in FIGURE 5 shows the phase-locked loop. The phases θ_1 from the incoming signal, and θ_2 from the local oscillator, are compared to create an error signal. This error signal feeds an integrator which changes its value when the error is non-zero. The VCO will then speed up or slow down accordingly.

This kind of clock regeneration will work even if the signal temporarily disappears since the phase-locked loop is designed to allow for only very small changes per bit. It is not until the VCO moves a significant fraction of a bit cell that errors can occur. We are, however, left with the requirement of the initialization of the clock regeneration which will be discussed under the subject of "headers and formats" in a later article.

CONTEMPLATION

We have shown how different codes can achieve the same bit rate with a different transition rate. Let us ask about the limit of the process. Could we design a code which required still less bandwidth to produce the same data rate? The answer is yes. The following code has a still lower transition rate. To implement this code we take two bits at a time and create transitions according

to the following rules:

| | |
|----|------|
| 00 | 1.8T |
| 01 | 1.9T |
| 10 | 2.1T |
| 11 | 2.2T |

where T stands for the nominal time between bit cells from our previous discussion. Notice that on average, this code produces transitions which are half as often as the previous MFM code. For the same bandwidth it can achieve twice the bit rate.

This is not a good code, but the issues that it illustrates are instructive. The bandwidth limits of a channel mean that transitions which are too close together will merge because the amplitude response of the channel decreases;

the upward transition merges with the downward transition or the signal never gets to its full value before beginning down again. This is shown in FIGURE 6A. At some frequency, nothing comes out.

Our new code, shown above, does not have that property because the transitions are widely spaced. However, we must resolve the difference between a width of 2.1T and 2.2T as shown in FIGURE 6B. We require a fine resolution on differential time detection. Because of the reduced bandwidth, this assumes a good S/N. We see that bandwidth and bit rate are not the only metrics of a code's performance.

We will continue this discussion next month. ■

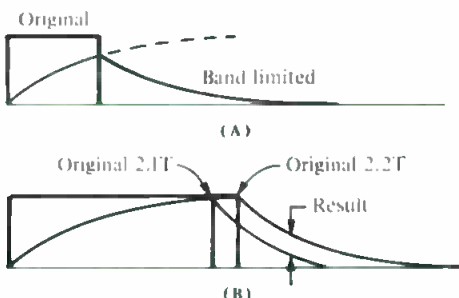

Figure 6. The effect of limited channel bandwidth, showing (A) input and output with classical code and (B) the same but with a "funny" new code.

great gauss good price

Introducing 8 new affordable musicians' instrument speaker systems — from Gauss.

High quality Gauss at an affordable price? Right! Through creative engineering design, the 4 systems here are actually 8. This innovative math makes it possible for us to price all these cost effectively. The product hasn't changed. Each still has the same superior power handling, efficiency, and 5-year speaker warranty. Plus, all 8 have parallel phone jacks and 8 Ohm nominal impedance.

Hearing the product and the price will make you a believer in our math. Hear Gauss at your nearest dealer — the price is right.



5120



5180



5110



5181

1&2 5120 12" Rhythm or Lead Guitar with open back. 150 Watts RMS. **OR:** Mid-high element to use with Bass. Infinite baffle closed back.

3&4 5110 Double 10" Rhythm or Lead Guitar with open back. 300 Watts RMS **OR:** Mid-high element to use with Bass. Infinite baffle closed back.

5 5181 18" Slot-loaded horn Bass Guitar Bottom. 400 Watts RMS.

6 5110/5181 Low/Mid-high Bass Guitar System

7 5180 18" Bass reflex Bass Guitar Bottom. 200 Watts RMS.

8 5110/5180 Low/Mid-high Bass Guitar System.

Cetec Gauss
 9130 Glenoaks Boulevard
 Sun Valley, CA 91352
 (213) 875-1900
 Telex: 194989

In Canada:
 Omnimedia
 9653 Cote De Liesse
 Dorval, Quebec H9P 1A3
 (514) 636-9971

Sound Reinforcement

Extending Power Bandwidth at Low Frequencies: Mutual Coupling

• In most music reinforcement systems, flat power response down to 40 Hz is felt to be sufficient. However, certain special effects, both in music reinforcement and in the motion picture theater, require extension of the low-frequency bandwidth down to 25 Hz. Because of the ear's relative insensitivity to very low frequencies, considerable amounts of acoustic power must be generated if the effect is to be a strong one. The phenomenon of mutual coupling works in our favor by increasing the efficiency of multiple low-frequency radiators over that of a single low-frequency.

CALCULATIONS OF REVERBERANT LEVEL

In most applications of sub-woofers in indoor situations, we are concerned with the reverberant level, which exists fairly evenly throughout the room, instead of the level of the direct field. In order to calculate this, we must know

two things: the total acoustical power output of the loudspeakers and the room constant in the frequency range of interest.

The equation which relates these quantities to sound pressure is:

$$P = \left[\frac{4 \rho_0 c W}{R} \right]^{1/2}$$

where P = total acoustical power output,

ρ_0 = pressure in pascals (newtons/meter),

c = speed of sound, in meters/second,

W = acoustical power, in watts

R = room constant, in meters squared.

Converting this equation to a handier form, we have

$$\text{dB - SPL} = 126 + 10 \log (W/R).$$

For a sample calculation with a single low frequency transducer, we refer to the manufacturer's specification sheet and note that the reference efficiency of a given 460 mm (18 in.) driver is 2 percent, and that its continuous input power rating is 200 watts. We can now calculate the maximum acoustical power the driver can produce:

$$200 \times 0.02 = 4 \text{ acoustic watts.}$$

Let us place this low frequency system in an enclosed space whose room constant at low frequencies has either been measured, or estimated, to be 2000 meters squared. Then:

$$\begin{aligned} \text{dB - SPL} &= 126 + 10 \log (4/2000) \\ &= 99 \text{ dB - SPL.} \end{aligned}$$

Through mutual coupling, the net efficiency of n identical LF drivers will simply be n times the efficiency of a single unit. Thus, for two drivers of the type used in the preceding example, the efficiency will be 4 percent. Now, let us work our example again, assuming that each driver will see 200 watts:

$$400 \times 0.04 = 16 \text{ acoustic watts,}$$

and:

$$\begin{aligned} \text{dB - SPL} &= 126 + 10 \log (16/2000) \\ &= 105 \text{ dB - SPL.} \end{aligned}$$

Thus, doubling the number of drivers and doubling the power available, we have increased the reverberant sound pressure level by 6 dB. We will leave it to the reader to show for himself that four low-frequency drivers would produce 111 dB-SPL, and eight would produce 117 dB-SPL.

Can we continue that process indefinitely? The answer is no. If we could, then it would be no problem at all to exceed 100 percent efficiency! What happens as we increase the number of units in the low-frequency array is that the frequency below which we observe mutual coupling keeps moving lower. (See FIGURE 1) A convenient equation for determining the upper frequency bound on the effect is:

$$f_{\max} = c/d\sqrt{n},$$

where c = speed of sound,

d = nominal spacing between drivers,

n = number of drivers.

Thus, for our examples above:

$$\begin{aligned} \text{Two drivers: } f_{\max} &= 344/.46\sqrt{2} \\ &= 528 \text{ Hz.} \end{aligned}$$

$$\begin{aligned} \text{Four drivers: } f_{\max} &= 344/.46\sqrt{4} \\ &= 374 \text{ Hz.} \end{aligned}$$

The reader can solve for f_{\max} with the ensemble of eight low-frequency drivers, and he should get the answer 264 Hz.

The above equation assumes that the low-frequency drivers are located as close together as possible, and this is an important rule in getting the most out of mutual coupling. Another rule we should remember is that we cannot get efficiencies much over the 15-20 percent range, so in the examples above eight low-frequency units would represent the limit for mutual coupling. Of course, we can always add more low-frequency units if we need more level, but we must remember that the efficiency of the ensemble will not increase substantially in the process.

PERFORMANCE OUT-OF-DOORS

In a typical outdoor situation we would use inverse square relationships in determining the level at a given distance. The effect of mutual coupling here is to increase the sensitivity of the low-frequency drivers by 3 dB with each doubling of units over that of the single unit. ■

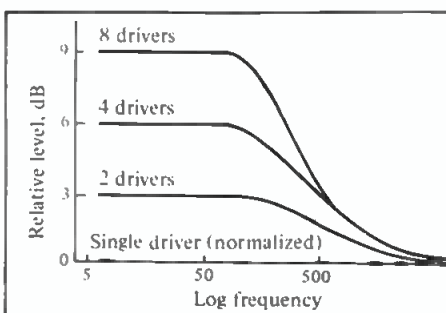

Figure 1. Mutual coupling at low frequencies for 460 mm (18 inch) low-frequency drivers.

Introducing

THE SOUND EFFECTS LIBRARY FOR PROFESSIONALS

- 3000 STEREO EFFECTS
- 300 PAGE CATALOGUE
- 30 HOURS OF SOUNDS
- 125 TAPES at 7 1/2 or 15ips
- PRICED FROM \$1500.00

"Some of our Clients."

- ABC
- NBC
- Walt Disney Prod.
- Universal Recording

86 McGill Street,
Toronto, Ontario
Canada M5B 1H2
(416) 977-0512

REGARDING COMPACT CONSOLES...

For the first time, a truly professional compact console... the new JH-800 from MCI.

The world's most experienced console designer now offers the same features and performance you've come to expect from larger MCI studio hardware... all in a compact configuration that provides a professional solution to your location recording, video production and outside broadcast needs. The JH-800 is packed with features never before found in a console of this size. 12 inputs with four VCA groups. Two stereo mix busses. Multi-way input connectors. Four sends for effects and foldback. Three echo returns. Separate, balanced, transformerless XLR line and microphone inputs for "studio style" overdub and monitoring capabilities. Exclusive MCI Broadcast Logic signal flow. A comprehensive communication system with talk-to-cue and independent two-way communication for up to three different locations.

The new JH-800 from MCI. A truly professional compact console.



WE JUST BUILT ONE FOR THE PROS.

Call Sony Broadcast in New York/New Jersey at (201) 368-5085; in Chicago at (312) 860-7800; in Los Angeles at (213) 841-8711; in Atlanta at (404) 451-7671; or in Dallas at (214) 659-3600.

SONY
Broadcast

Circle 24 on Reader Service Card

© 1983 Sony Corp. of America. Sony is a registered trademark of the Sony Corp.

Sound With Images

A Worthy Competitor For Digital Audio

• A few months ago, in this very space, I tried to do a little crystal ball gazing concerning the nature of the then-still-secret audio recording system known as Beta Hi-Fi. In my most scholarly fashion, I searched for obscure technical papers that might reveal the true nature of this revolutionary audio-for-video recording technique. I came upon a paper by some Hitachi engineers¹ that talked about adding audio to the composite video signal using one or more FM carriers mixed in with the chroma and luminance signals. I found another paper which showed how PCM audio could be added to the video signal of a VCR without degrading picture quality, by Sony engineers², of all

people. (It was, after all, Sony who developed the still-secret Beta Hi-Fi which they said, even then, was *not* a digital system.) A month or so later, I uncovered a clever stereo audio system that could be broadcast as part of the video signal (and could therefore, ostensibly, be recorded on tape by the fast-spinning video heads, much as the video signal itself is laid down on the tape); that paper was by as unlikely a proponent as Grumman!

THE MYSTERY REVEALED

Well my friends, the suspense is over. Beta Hi-Fi, revealed in all (or almost all) its glory at the recently concluded Winter Consumer Electronics Show in

Las Vegas, turns out to be neither PCM digital, nor formed of a color stripe on the edge of the picture (a la Grumman's answer for more audio channels in video). Rather, it comes closer to that obscure Hitachi paper which I quoted earlier, in that it utilizes FM carriers which are modulated by left and right channel audio information. The two extra carriers are nestled in between the chrominance and luminance channels currently used in recording video using the Beta format, as illustrated in simplified form in the lower diagram of FIGURE 2. (In reality, the block of frequencies labeled "A" for AFM audio consists of two separate and discrete carriers—one for left chan-

SYSTEM 5

REAL REVERB, NOT JUST EFFECTS!

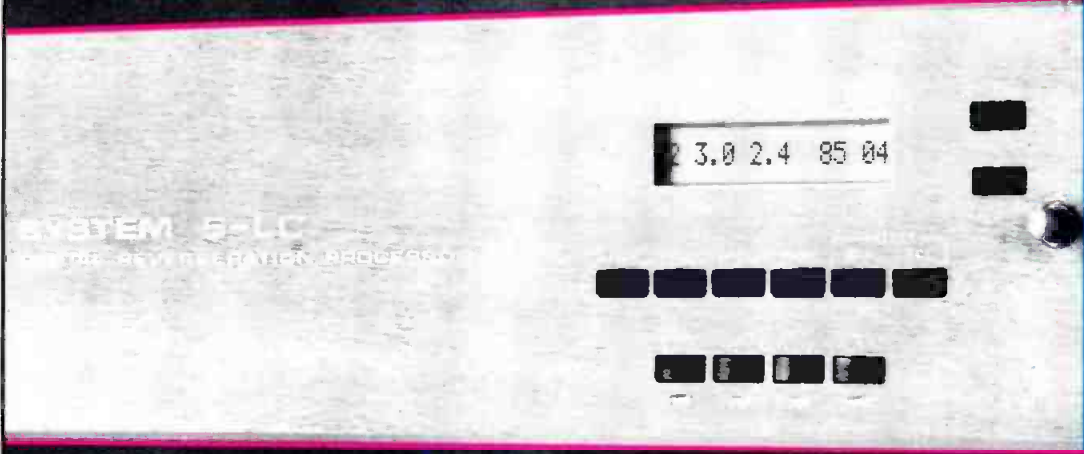

Real reverb, not just another effects box! Just as the new SYSTEM 5 sets the performance standard for digital reverb, the SYSTEM 5-LC offers the same sonic performance as the SYSTEM 5 with the cost savings of an LCD front panel control.

The SYSTEM 5-LC has the same function, the same new and improved programs, same performance, and the same reliability as the SYSTEM 5, but at a new low price. You also have the option of adding the same full function remote control from the SYSTEM 5 for the best of both worlds.

Check it out, hear the even more affordable SYSTEM 5-LC at your QUAD-EIGHT dealer.

Quad-Eight Electronics For the artist in every engineer.
 11929 Vose St., North Hollywood, CA 91605 • 213-764-1516 • TLX: 66-2446 QUADFATHER LSA

db March 1983

22

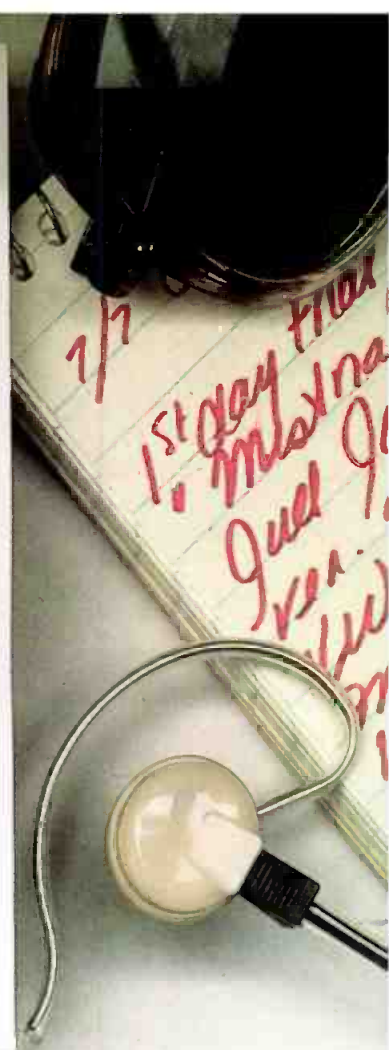

**Amid the hostility, the confusion, the competition,
one microphone stands above the crowd.**

The SM63.

No matter how rough things get in the field, the Shure SM63 Omnidirectional Dynamic Microphone gives your crew the whole story with a lot less handling noise than any microphone in its class. When Shure's engineers developed the SM63 and SM63L (with longer handle), their objective was to create a high-output, lightweight microphone perfect for the needs of electronic news journalists.

With the SM63's patented internal mechanical isolation system reducing undesirable handling noise, its high output and smooth extended frequency response lets your story come through crisp and clear. Its omnidirectional polar pattern prevents boominess that is often encountered during close miking situations. And its overall lightness makes continuous hand-held ENG/EFM assignments less fatiguing, without sacrificing ruggedness. Even its profile is small and elegant so it won't obscure faces on camera.

The output of the SM63 is a full 6 dB higher than comparable hand-held interview microphones.

And there are even more precision-engineered refinements. A highly effective internal humbucking coil rejects strong magnetic fields encountered around lights and other broadcast situations. And when things get really tough, the Shure-developed VERAFLEX® grille is virtually impervious to rust, moisture and dents. This system includes a highly effective internal anti-wind and -pop filter; and for more adverse conditions, a dual-density two-layer windscreen also is supplied.

The Shure SM63. The hard-working microphone for the working press.

For more information on the complete line of professional broadcast products, call or write Shure Brothers Inc., 222 Hartrey Ave., Evanston, IL 60204, (312) 866-2553.

SHURE®

THE SOUND OF THE PROFESSIONALS®...WORLDWIDE

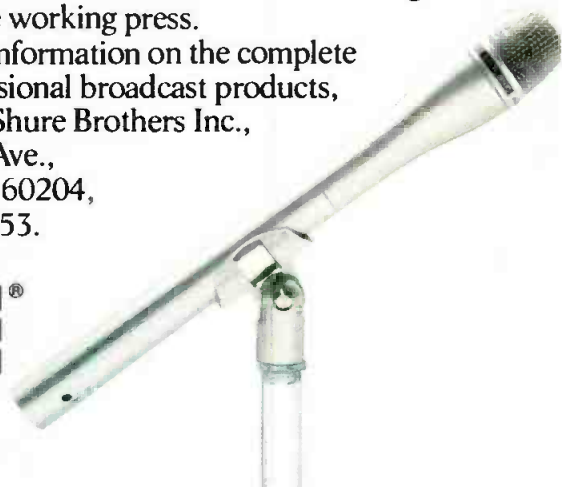

Take Us For Granted

With 24 tracks going, you don't have time to reach over and adjust for tape-induced level variation. You want to be able to forget about the tape.

Which is why we test every reel of our 2" Grand Master® 456 Studio Mastering Tape end-to-end and edge-to-edge. To make certain you get a rock-solid readout with virtually no tape-induced level variation from one reel of 456 to

another or within a single reel.

No other brand of tape undergoes such rigorous testing. As a result, no other brand offers the consistency of Ampex Tape. The consistency that lets you forget our tape and concentrate on the job.

AMPEX

Ampex Corporation • One of The Signal Companies 

Ampex Corporation, Magnetic Tape Division
401 Broadway, Redwood City, CA 94063
(415) 367-4463

**4 out of 5 Professionals Master
on Ampex Tape.***



*1981-1982 Billboard Magazine
Brand Usage Survey

Circle 25 on Reader Service Card

www.americanradiohistory.com

Conventional Audio Characteristics

| | S/N | FREQUENCY RESPONSE | WOW AND FLUTTER | DISTORTION |
|-------------|----------------|--------------------|-----------------|------------|
| βII | MORE THAN 40dB | 50Hz-11KHz | 0.3% (WRMS) | 3.0% |
| βIII | MORE THAN 40dB | 50Hz-8KHz | 0.4% (WRMS) | 3.5% |

Beta Hi-Fi™ Audio Characteristics

| | DYNAMIC RANGE | FREQUENCY RESPONSE | WOW AND FLUTTER | DISTORTION |
|---------------------|----------------|--------------------|-------------------------|----------------|
| βII AND βIII | MORE THAN 80dB | 20Hz-20KHz | LESS THAN 0.005% (WRMS) | LESS THAN 0.3% |

Figure 1. Comparison chart of audio specifications.

nel, the other for right channel—resulting in excellent stereo separation.)

Anyone who has had the misfortune of having to record serious audio material on the audio tracks of VCR (even the so-called professional U-Matic ¾-inch types) knows that the

quality of sound obtained during playback leaves much to be desired, both in terms of frequency response and dynamic range. Signal-to-noise ratios are severely limited to between 40 and 45 dB for the complete record/playback cycle, unless some form of

noise reduction or companding is used. And even if companding is used, the poor overall bandwidth capability of the system makes tracking of such companding systems extremely tricky and subject to large errors. In short, for most conventional VCRs, tape hiss is

Beta Hi-Fi™ Video Head Frequency Spectrum

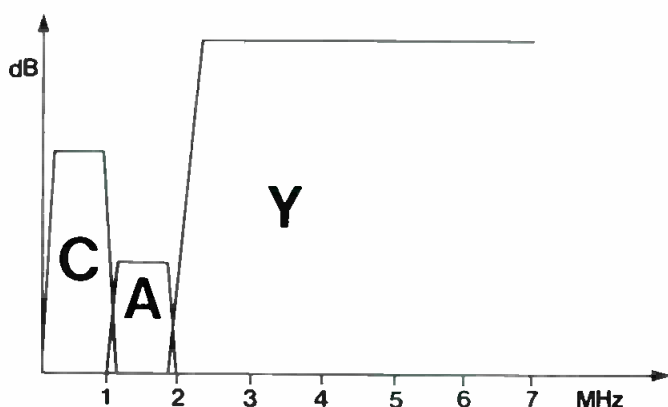

Conventional Video Head Frequency Spectrum

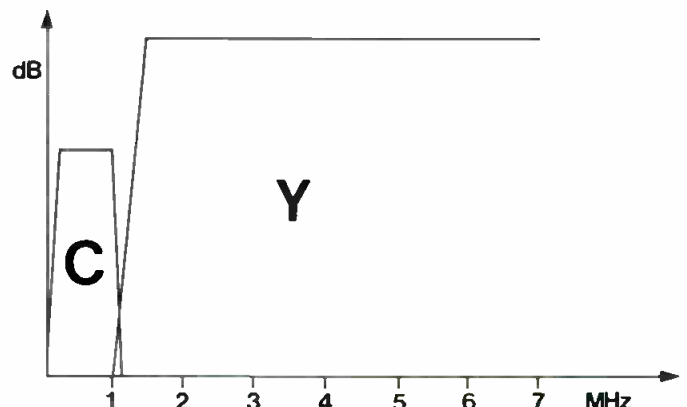

C=CHROMINANCE A=AFMAUDIO Y=LUMINANCE

Figure 2. Comparison chart of video head frequency spectrum.

very audible, even when operating at the faster tape speeds. It should be pointed out that even at these speeds, tape motion is *slower* than the tape motion in a standard cassette tape deck! Distortion of the audio track on a VCR is fairly high, too. Furthermore, until very recently, the audio track on both VHS and Beta machines has been limited to single-channel sound. A few VHS machines have been introduced in the past couple of years that do offer two-channel audio, but the audio quality of the two channels is no better than that of the mono machines. In fact, since the narrow, longitudinal audio track assigned to audio in the VHS format has to be split in two to create two separate channels, audio quality actually deteriorates by about 3 dB. Finally, if you have ever listened to the sound of a sustained instrument tone played back from a VCR (such as that of a piano or guitar), I don't have to tell you about wow-and-flutter from the audio track of VCRs.

Given that background, it is easy to understand why Sony considers their new Beta Hi-Fi audio recording system to be such an important development. Consider the performance specifications claimed (and aurally confirmed) and you'll see what all the fuss is about.

Beta Hi-Fi offers a total dynamic range (and therefore a maximum signal-to-noise ratio) of 80 dB! That's nearly two whole orders of magnitude better (if we talk audio power) than the best LP discs currently available. It's a whole order of magnitude better than the kind of signal-to-noise ratio you can expect from an open-reel master tape after it's gone through at least one mixdown and through a console. And, getting to the point I'm trying to make with the title of this column, it's not all that much less than the dynamic range achievable with digital audio program sources as they are presently offered by commercially available PCM digital audio processors. Doesn't that suggest an economical way to improve the quality of your mastering system without spending the big bucks for a pro digital mastering system?

BETA HI-FI VS DIGITAL AUDIO

Given the superb performance of Beta Hi-Fi as a strictly audio recording technique, could a professional ground swell develop which would favor using this recording system as a mastering system that's better than any present day audio analog recording system and doesn't have the "negatives" sometimes attributed to digital sound? One factor that makes that a possibility is the relatively low cost of Beta Hi-Fi video recorders. They are expected to add only about \$100.00 or so to the cost of an

equivalent conventional VCR. Even if you totally ignore the fact that these machines can record pictures and use them only for high-quality audio mastering, they still end up cheaper than PCM (digital) audio processors coupled to video tape recorders.

To be sure, editing would still be a problem, but it's a problem with digital audio mastering systems, too—unless you're prepared to spend more big bucks for a digital editing system. And, on the positive side, if you aren't convinced that digital sounds great in its presently available formats, here's a way to achieve remarkably good performance while staying in the analog sound domain. There's no rule that says you have to attach a camera to a Beta Hi-Fi VCR if all you want to record is a pair of superb audio channels.

In this country, at least, the Beta format has been outsold by VHS VCRs

by a factor that's running about 7-to-3 at the moment. With the introduction of Beta Hi-Fi, Sony and friends hope to reverse that trend. And there are now more friends than before. Companies previously committed to the Beta format (either as manufacturers or distributors) besides Sony include Aiwa, Marantz, NEC, Sanyo, Sears, Teknica, Toshiba and Zenith. With the introduction of Beta Hi-Fi, two more names, noted more for their audio products than for any involvement in video, have become licensees for the Beta format. They are Pioneer and Nakamichi.

Other performance specifications of the Beta Hi-Fi system are equally impressive. For example, wow-and-flutter is down to a negligible 0.005 percent! Distortion, even at maximum (0 dB reference) record level, is one-tenth that measured on typical conventional VCRs, or 0.3 percent. And, as you might have guessed, frequency response is just about ruler flat from

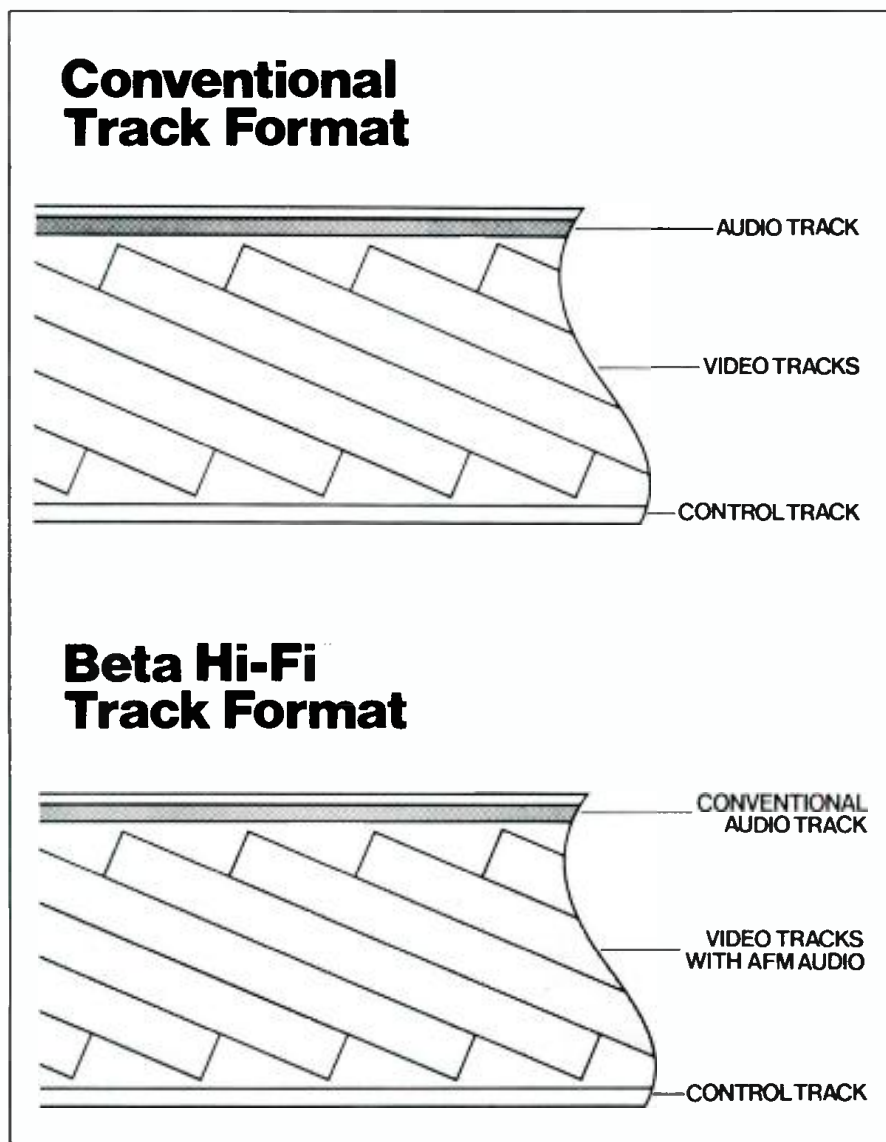

Figure 3. Comparison chart of track formats.

20 Hz to 20,000 Hz. These performance specifications are summarized and compared with the results presently available from the audio track of a conventional Beta machine in FIGURE 2. (VHS types do just about as poorly, incidentally.)

As indicated in FIGURE 3, the Beta Hi-Fi track format allows for total compatibility with earlier hardware and software. That is, an older Beta video cassette played on a new Beta Hi-Fi type VCR will still deliver the same (albeit inferior) audio sound as before. And, because newer Beta Hi-Fi cassettes will have a monophonic (L + R) equivalent sound track recorded longitudinally where it always was (in addition to the two FM-modulated audio tracks that become part of the video composite diagonal tracks), newer tapes can be played back on older Beta-format machines. The availability of three audio channels suggests, too, that some enterprising software producer will, sooner or later, come up with a movie that employs ambience enhancement using the third, limited bandwidth longitudinal channel. We all learned early-on that you don't need a lot of treble response for an ambience channel, right? So why not a three-channel audio system that would bring us closer to the "movie house" experience?

An interesting side benefit arises from this arrangement, besides the

superb performance already outlined. If you operate the fast scan feature of a Beta VCR (say, at twice or three times normal viewing speed), the audio doesn't take on the "chipmunk" quality that is characteristic of conventional audio tape reproduction at higher than normal speeds. If you stop to think about it, actual tape-head to tape writing speed doesn't really change that much when the longitudinal tape speed is increased by two or three times or, for that matter, when it is decreased by slow-motion viewing. That's because the longitudinal tape speed is a very small part of the total effective tape-to-tape-head writing speed when we talk about the video recording heads. In other words, the speed of speech will increase, but the pitch of the voice of the speaker will remain virtually unchanged. Doesn't that suggest some commercial applications? There seems to be a lot more to this Beta Hi-Fi thing than just a way for Sony and its licensees to pull ahead of the VHS camp.

In fact, if that were the sole objective of the introduction of Beta Hi-Fi, I would have to conclude that it is already doomed to failure. Both JVC (the developers of the competing VHS system) and their sister company Panasonic have already demonstrated prototypes of stereo audio systems that also employ FM carriers within the

VHS frequency spectrum and format. Originally, Sony had implied that VHS adherents would have a rough time duplicating the Beta Hi-Fi audio feat in their format, but obviously, like so many other video innovations, if they can be done in Beta, VHS people usually figure out how to do them in VHS. What remains to be seen is whether the VHS version of the new audio system will in any way "rob" the picture of its resolution or quality. For the pro audio user who sees this novel audio recording system as an entity apart from video, that would not be of particular concern.

It will be interesting to see whether or not the introduction of Beta Hi-Fi (and perhaps its VHS cousin) actually becomes serious competition to digital recording techniques in the months and years ahead. That would be somewhat ironic, in view of the fact that Sony (and most of its licensees) has a big stake in the success of digital audio, too. ■

References

1. K. Mohri, et al. "A New Concept of Handy Video Recording Camera." IEEE Transactions on Consumer Electronics, Vol. CE-27, No. 3, August 1981.
2. K. Nakano, et al. "A New 8-Bit PCM Audio Recording Technique Using An Extension of the Video Track." IEEE Transactions on Consumer Electronics, Vol. CE-28, No. 3, August, 1982.

MASTER EQUALIZATION

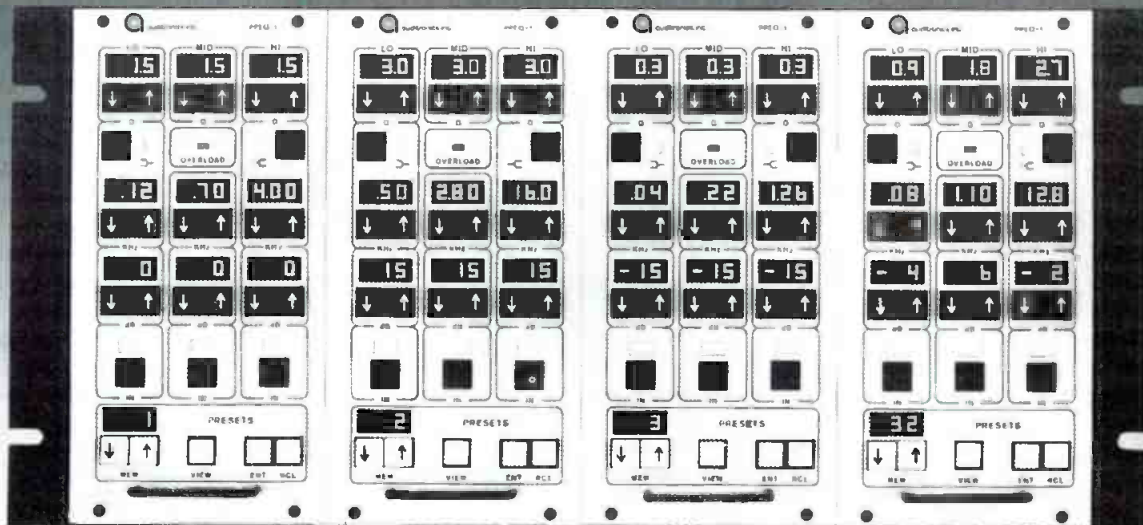

The PPEQ-1 Programmable Parametric Equalizer, the ultimate audio production tool. Full function 3 band equalization with up to 4 mono or stereo units in a single 19" rack mounting package. 32 on-board non-volatile memories per unit, constant access to and display of all parameters, and available with remote control.

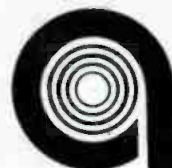

audionics, inc.

3750 Old Getwell Rd.
Memphis, TN 38118 USA
Tel: (901) 362-1350
Telex: 533356

Call collect for complete information.

Circle 26 on Reader Service Card

www.americanradiohistory.com

We're Still Here

ALTHOUGH THE YEAR is still reasonably young, at least one of our readers has taken us to task for being a little bit too successful in becoming invisible, as predicted on this very page in January. Well now, there's invisible and then there's ...uh, Invisible. Obviously, we were referring to the former, while our reader-friend was referring to the latter.

On the off-chance this isn't crystal clear, our last few issues have been showing up a bit late. It all began some months ago when we took on the publication of a new—for us, that is—magazine, the popular *Modern Recording & Music Magazine*. As the two staffs merged (or collided, depending on who's telling the story), there were the inevitable disruptions that took a while to get resolved. During that time, the db production schedule slowed down a bit. The result: a late January issue, followed by a still-later February issue. Hence for the month of February, it appeared that our predictions of invisibility were succeeding beyond our wildest dreams.

Not quite. We were just a bit late in reaching you, but eventually, there we were. And here we are again—still a bit late, but catching up. By next month (well, maybe next month), we'll be back on schedule again.

Meanwhile, the NAB convention is fast approaching (April 10-13). When we saw our April Broadcast Audio issue was not going to make it in time for the big show, we quickly called (collect) our man at the Las Vegas Convention Center and asked him to have the convention delayed a month or so. We offered him \$100 to take care of the details. (After all, what's an editorial budget for?) He hung up on us. (Some people just can't handle stress.)

As we started to re-dial, we had another one of our brainstorms—and this one saved us \$100. We would simply make March our NAB issue. So here it is—still a little late, but well in time for the convention.

In our last issue, we finally began doing equipment reports. As promised, these will not be the usual “put it

on the bench and plug it in” type of reviews. Instead, we'll put the gear to use, and do our best to blow it up under actual studio conditions. We'll report here on what happens.

Now that we've had a review in every single issue since February, 1983, we figured we were ready for the big time. Why not review a console—better yet, a broadcast console? We discussed the idea with Ken Pohlmann at the University of Miami, whose reaction was immediate. He complained of a head cold and took the rest of the day off. Nevertheless, we persisted, and while he was out sniffing, we laid the board on his desk (it's a big desk, and a rather small board).

Next day, it was gone (the board, not the desk), and so was Pohlmann. A student stoolie reported seeing him driving off with the board (no doubt in a stolen car). After talking to the local police precinct (but before we figured out how to explain the missing console to MCI), Pohlmann reappeared.

“Aha,” we said. “Returning to the scene of the crime, are you?” To which he replied, “Don't be a jerk. I forgot the power supply, and the opera starts this evening.”

“You're taking the console to an opera?!”

“How else do you think I'm going to be able to destroy it? Don't you remember what Murphy has written about the inverse relationship between reliability and curtain time?”

“Now don't start getting technical with me, fella! We can always get Mark Goode back to repeat his February success.”

“Are you kidding? He left for Tahiti with the ten bucks you gave him for that review.”

We decided to give Pohlmann another chance. We called off the cops and, sure enough, a few days later the console reappeared, along with his report which you'll find in this issue.

As soon as Mark Goode returns from his South Pacific holiday, and Pohlmann gets the kinks out of his back, we'll have some more reviews for you. In the meantime, let us know what you'd like to see next.

JMW

Digital Broadcasting: Upcoming Revolution?

The following is an overview of digital broadcasting, focusing on four systems designed to provide digital transmission of audio via satellite.

DURING THE LAST decade, significant progress has been made in digital audio recording. The audio professionals have carefully monitored these developments, discussed them, evaluated them, adopted some and rejected others. Today, you hardly find a trade magazine that does not publish articles on the subject, and lately, these articles have begun appearing by the hundreds.

And all this time, while the recording industry loudly discussed the pro's and con's of digital audio distribution, work in the broadcast industry attracted little attention.

However, the needs for wide band, distortion free transmission of audio were well recognized and considered important.

In television broadcasting, for example, audio had been limited to 5 kHz by virtue of the fact that television networks routinely used (and are still occasionally using) wire-based 5 kHz circuits; not much on quality, though reliable and cost-effective.

The first digital transmission of sound for television was developed by the BBC and started in 1972. It employed PCM coding, with a sampling rate of 26 kHz, 13-bit quantization, and offered a mono 14 kHz audio channel. The data stream was transmitted on a carrier inserted into the horizontal blanking interval.

In 1973, the Public Broadcasting System (PBS) and the Digital Communications Corporation (DCC) developed the DATE (Digital Audio for Television) system to transmit four 15 kHz channels of audio for television.

Since then, several systems for broadcasting have been developed. Among these systems are

ADDS—Audio Digital Distribution System developed by Scientific Atlanta and RCA.

M/AESTRO—developed by DCC and AT&T.

Sony System—developed for DFVLR, a television station in West Germany.

These systems are not compatible with each other. However, all of them are designed to offer digital transmission of audio via satellite.

Satellite transmission provides relatively easy and inexpensive means for point-to-multipoint distribution of audio and video. There are generally two types of transponders available on satellites; C-band, in the 6-9 GHz band and Ku-band in the 12-14 GHz band.

Transponders are normally used for retransmission of video or audio carriers, a combination of the two, or data. Most of the currently operational domestic transponders

Vladimir Nikanorov is vice-president, engineering, at Muzak Corp.

Morris Weinman is a staff engineer for Group W Cable, and a specialist in the field of satellites.

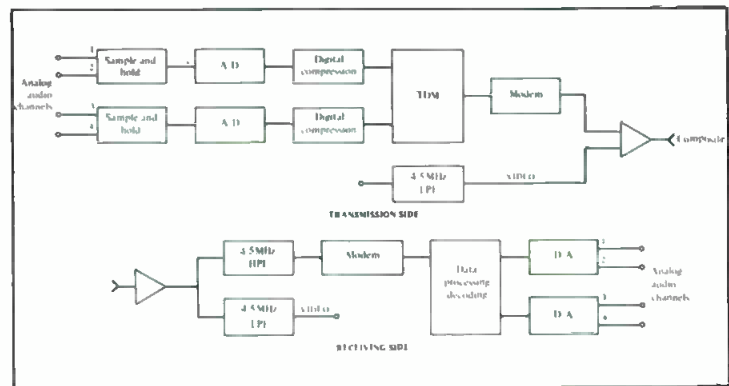

Figure 1. A block diagram of the DATE (Digital Audio For Television) System.

(about 150) retransmit video carriers. Some of them (for example, WGN) accommodate multiple additional audio carriers (in WGN's case, up to 15).

The others are SCPC (Single Channel-Per-Carrier) and are used to retransmit multiple carriers with audio.

SYSTEMS DESCRIPTIONS

The DATE system is designed to transmit digitized sub-carriers on video channels and could be used either for providing high quality audio to a television channel or as an addition to a regular audio analog subcarrier to transmit independent audio channels. All audio channels must originate from a single uplink.

The ADDS is essentially an SCPC arrangement providing up to 20 audio channels on a single transponder. This system is adapted and is being installed by the major radio networks: ABC, CBS, NBC and RKO.

M/AESTRO is another SCPC system, however designed for an independent broadcaster or a network. The signals can be uplinked from a number of different places.

All of the above were designed for C-band transponders.

The Sony System was designed for Ku-band transponders and is essentially a single carrier system.

MAJOR PRINCIPLES OF DESIGN

Although the systems are not compatible, they show similarities in principle. All of them employ the PCM format, ranging from 13 to 15 bits of quantizing; none employ 16 bits, which seems to be getting acceptance as a standard for the recording industry.

After A-to-D conversion, the digital data is transferred from a PCM format to a different one for several reasons: to reduce the occupied bandwidth, to enhance signal-to-quantizing noise ratio and to reduce cost of the hardware. The Sony system, however, is an exception; it transmits the

PCM format without change.

The final data format is then time-division multiplexed and phase modulated; the resulting signal is then FM modulated and transmitted to satellite.

In 1978, PBS started to broadcast concerts with a sound track of unusually high quality. Although regular television sets are not able to reveal the full extent of the improvement, the clarity of the sound is quite noticeable. The system which provided this improvement was DATE.

DATE is capable of encoding four channels of 15 kHz audio and transmitting it on a 5.5 MHz video subcarrier. FIGURE 1 shows the general principle of the DATE system:

DATE uses a conventional PCM format, 14 bits quantization with a 34.4 kHz sampling rate for each analog audio signal of 15 kHz bandwidth. Two audio channels are fed into each A/D convertor.

On the receiving side, the process is reversed. When the law bit is received at 0 value, the three MSBs are restored as 0s. When the law bit is 1, the three LSBs are replaced with 100, which is considered as an average value.

There is actually a two-level error protection: one on the digital level, and another on the de-multiplexer level. The digital words are protected by the parity bit. The worst-case error on this level would be about three percent of the maximum peak voltage.

On the de-multiplexer level, a muting circuit is designed to ignore questionable digital words; the audio is gently muted when the error is detected, then returns to a normal level. The resulting Bit Error Rate (BER) is 10^{-5} , or 3 dB improvement from the noise level which would otherwise necessitate a higher-level carrier on the output of the FM transmitter. This brings the story to a description of how the

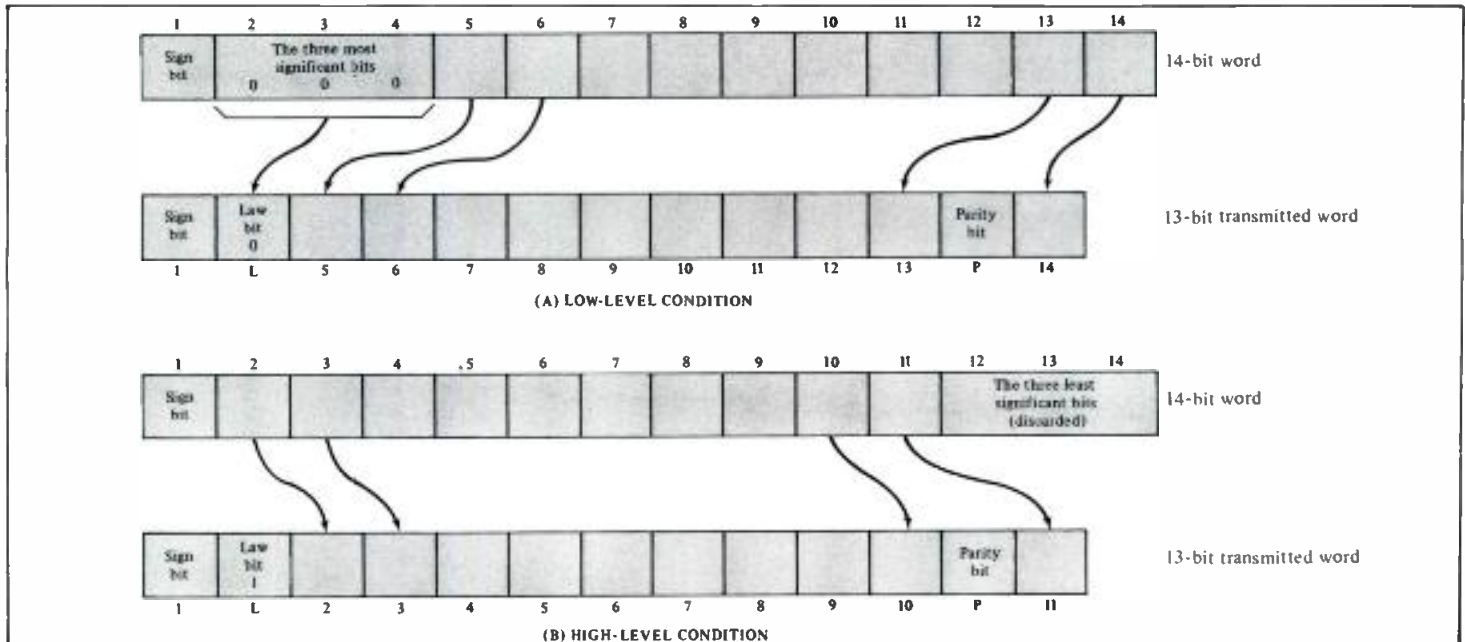

Figure 2. The DATE system's digital compression. In a low-level signal (A), when the three most-significant bits are 0, the transmitted law bit is 0. At higher levels (B), all three MSBs are not 0, and the law bit becomes 1. In this case the three least-significant bits are discarded.

The A/D convertors are used in a time-shared fashion. A sample of one of the audio channels is fed to the A/D convertor while a sample from the other channel is held; then the first channel sample is held and the second channel is fed to the A/D convertor. Each convertor provides for a dual audio channel.

At the output of the A/D convertor there will be two PCM-encoded data streams which are then processed in two stages. First it is digitally compressed, then it is combined into a single data stream by means of time division multiplex (TDM).

The instantaneous digital compression serves two purposes: one, it is a part of companding (expansion is used on the receiving side) which is used to reduce the quantizing signal-to-noise ratio; second, it reduces the number of bits in the transmitted digital word which in effect allows a reduced bandwidth.

Here is how it's done:

Each 14-bit word is compressed to 11 bits, with an additional "Law" bit and a parity bit. At the sample rate of 34.4 kHz, four 13-bit channels present a total bit rate of $34.4 \times 4 \times 13 = 1.79$ M bit/sec.

FIGURE 2 explains the general principle employed for the compression.

If the analog audio is at a low level, the three most-significant bits are at 0. They are transmitted as a single law bit with a value of 0. The parity bit is placed before the least-significant bit for the law bit protection. If the audio signal is of a high level then the three least-significant bits contribute little information describing the form of the signal and are dropped.

digital signal is transmitted.

TRANSMITTING THE DIGITAL SIGNAL

The digital stream is QPSK (Quadrature Phase-Shift Keying) modulated, and is fed into a modem. It consists of a differential encoder which provides for phase recognition, a modulator to modulate the phase-shifted 5.5 MHz subcarriers and a combiner which produces a multiplexed

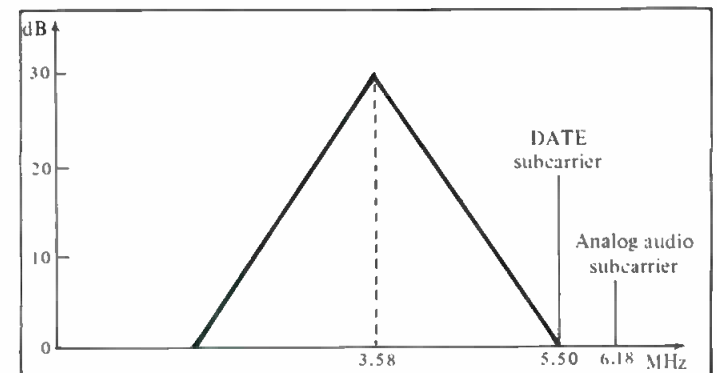

Figure 3. The video carrier, together with the DATE and analog audio subcarriers.

subcarrier to a video carrier. The needed bandwidth is 1.79 MHz; QPSK provides for 1 bit/Hz modulation. It is placed at 5.5 MHz on the video baseband at 16 dB below peak video.

FIGURE 3 shows a video carrier on a satellite transponder with a DATE subcarrier:

The resulting analog four-channel audio provides a fre-

quency response of ± 0.05 dB in the range of 20 Hz to 15 kHz, a signal-to-noise ratio of better than 70 dB and total harmonic distortion of less than 0.3 percent.

While DATE was transmitting high quality audio for PBS's 200 plus affiliates, Scientific Atlanta, in conjunction with RCA, was working on the ADDS digital system which would be able to serve a radio broadcasting network.

Again the major force behind this development was the realization that digitized audio can be distributed from point to multipoint without deterioration.

Actually the system was tailored to take advantage of the fact that the majority of radio network programming originates from one central area, New York City. This makes possible sharing a transponder on a satellite by the networks in a very cost effective manner.

Each satellite transponder under ADDS is capable of retransmitting 20 digitized 15 kHz audio channels or their equivalent (40 of 7.5 kHz channels and so on).

The system uses a 32 kHz sample rate with the 15-bit PCM format compressed to 11 bits, BPSK modulation, and a forward error correction circuit (FEC) with "hard decision" decoding circuitry.

FIGURE 4 shows a block diagram of how a dual-channel analog program is digitally processed for transmission via satellite.

Prior to digital processing, however, the analog audio is also processed. The analog signal is fed to a 3-pole RF low-pass filter, followed by a second-order high-pass filter of 8.76 Hz. It is then emphasized and clipped at a predetermined level, and fed into a 15 kHz antialiasing filter.

The processed audio is fed into sample-and-hold amplifiers which allow it to time-share the A/D convertors. The principle is the same as that used by DATE. A/D convertors convert the audio into a 15-bit digital word under 32 kHz sampling rate.

The digital words are then passed to holding registers which are essential in delivering the function of the address data base, and then to the digital compressor which compresses 15 bits quantity-per-sample to 11 bits. FIGURE 5 shows a table which explains the general principle involved.

Reduction from 15 to 11 bits is done as an approximation to a logarithmic compression characteristic. The top of the table in FIGURE 5 shows a distribution of values within eight

progressively higher-level 15-bit words. The bottom of the table shows that the lowest values are accurately preserved in words 0 and 1 and how a logarithmic compression characteristic is applied to words 2 through 7. As a result of this compression, the signal-to-quantizing noise ratio is reduced to 56 dB. The most important thing is that the low-level audio is preserved under the processing, which subsequently produces audio with a wide dynamic range.

The main advantage, however, of the compression is a reduced occupied bandwidth for each digitized channel.

The result of compression is 11 data bits plus a single parity bit which is used to reconstruct the 15-bit word. This type of coding is known as Folded Binary Coding.

The 12-bit data stream which represents audio information of a dual channel is then sequentially multiplexed (and coded by channel-select logic and timing control logic) on terminal multiplexer channels.

Each channel's total transmitted rate is 384 kbit/sec ($12b \times 32K$). Multiplexing 20 channels brings the total rate to a 7.68 Mbit/sec data stream. This resulting data is modified by a Forward Error Correction Circuit (FEC) which is the last digital processor before the modulator modulating the carrier with BPSK. FEC adds bits to the total data stream at the ratio of $\frac{7}{8}$ which brings the total bit rate to 8.77 Mbit/sec ($7.68 \text{ Mbit} \times 8 \div 7 = 8.777$).

Occupied bandwidth on the transponder is 17.554 MHz. BPSK modulates the signal at 1 bit per 2 Hz as opposed to QSPK's 1 bit/1 Hz; hence $8.777 \text{ Mbit} \times 2 \text{ Hz} = 17.554 \text{ MHz}$.

The received signal goes through the following stages, which are designed to gradually decode the signal to its original analog audio/form:

- 1) Demodulator,
- 2) Channel selection and timing control,
- 3) Error concealment.

The major difference with previously discussed DATE's error concealment is that ADDS substitutes a defective word with a previously used word, rather than muting the defective word completely.

- 4) Digital-to-analog convertor,
- 5) Sample-and-hold amplifier.

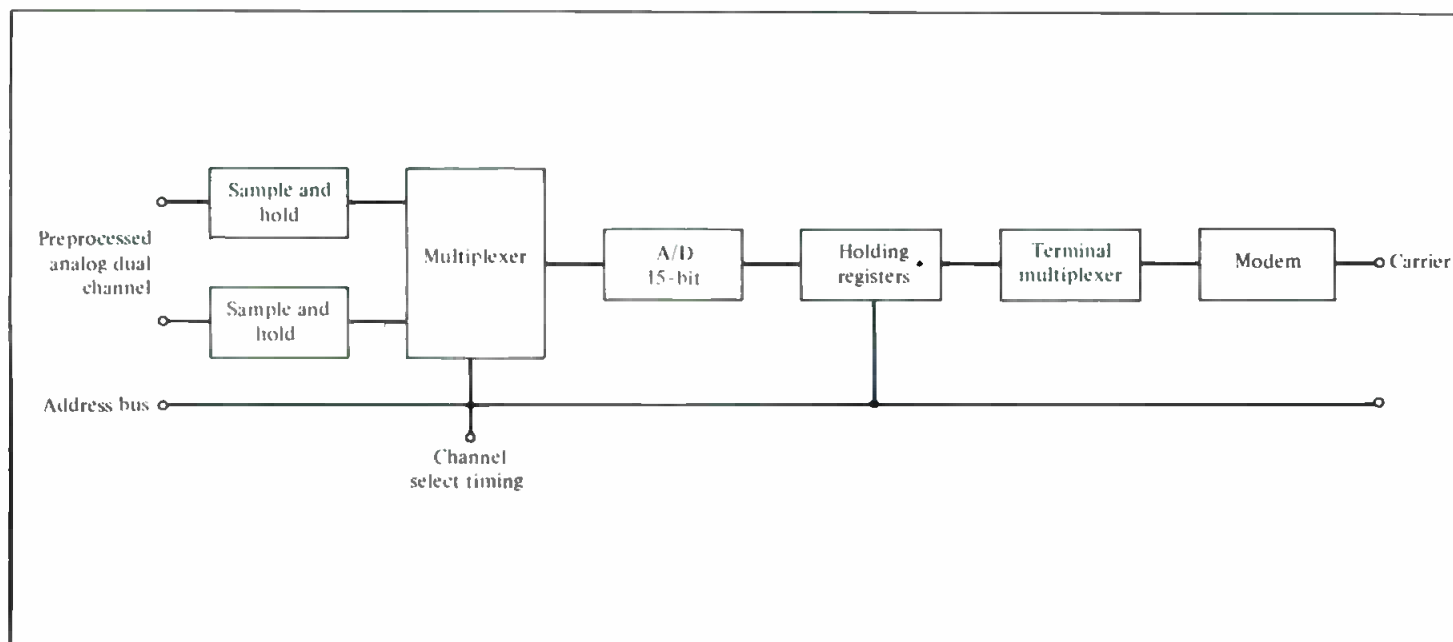

Figure 4. The ADDS system, showing a dual-channel analog program processed for digital transmission via satellite.

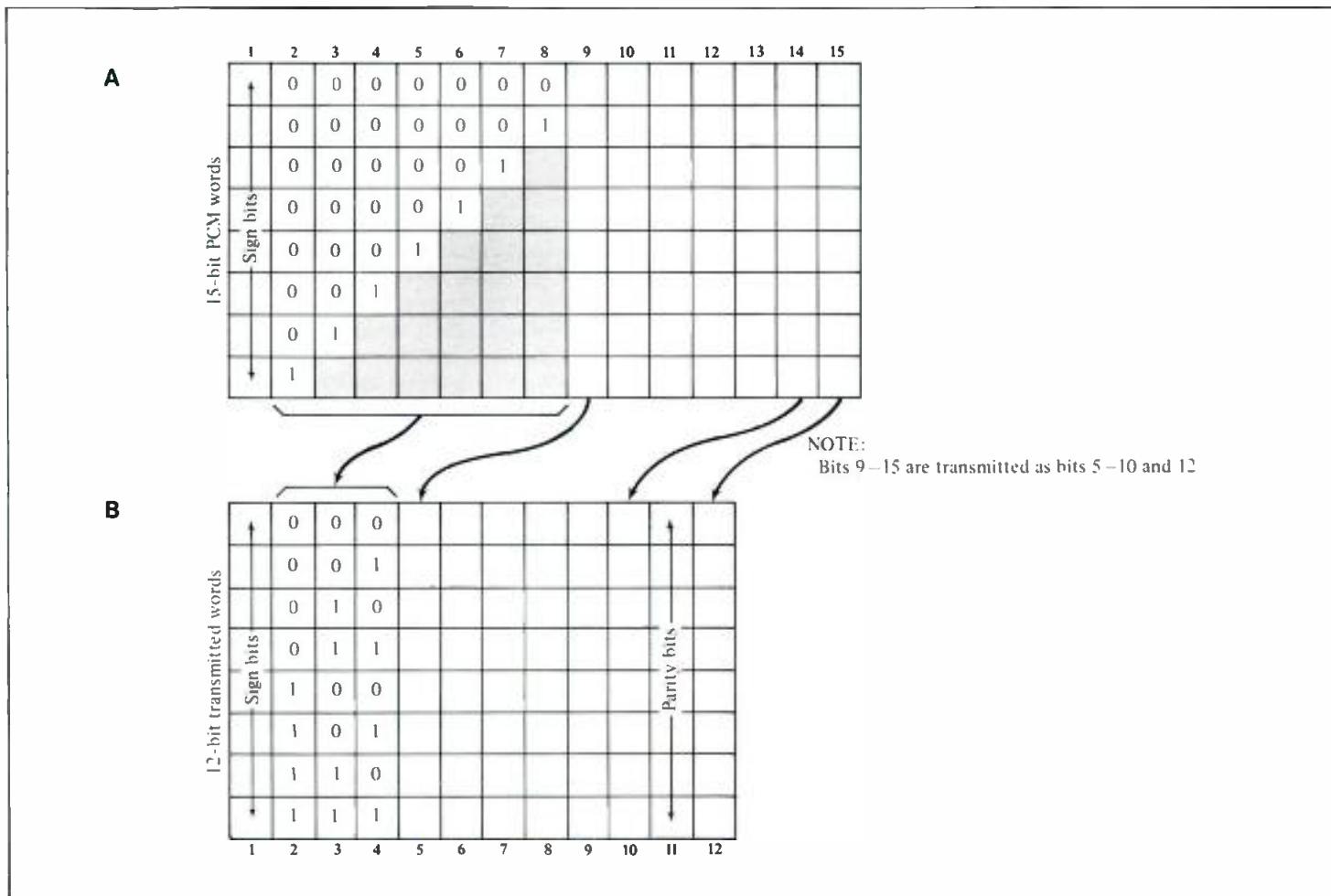

Figure 5. The ADDS compression system. The seven most- significant bits of each fifteen-bit word (A) are compressed into three bits (B) for transmission. The three MSBs in the transmitted words will have the values indicated, regardless of the actual values in the shaded area.

- 6) Distortion suppressor or deglitching amplifier. It is designed to correct switching transients, which can be present in the audio after conversion to analog and is controlled by the terminal demultiplexer.
- 7) 15 KHz low-pass filter,
- 8) Deemphasis.

Resulting audio signal offers 81 dB S/N; 0.3 percent THD and is flat within ±0.5 dB.

The system offers excellent performance; as was mentioned before, it is designed to be used by networks that will deliver their signals to the system for processing. The system will be installed at the uplink. It does not offer multiple access from different uplinks, which certainly doesn't make it attractive for a broadcaster who only transmits one or two channels. As it presently stands, not all 20 channels are used for audio; one of the 20 is used for housekeeping.

The networks are planning to digitize audio at the source. However, the ADDS system is not T1 compatible (T1 is a

The M/AESTRO system fills the needs of the individual broadcaster who cannot combine signals for transmission from a single uplink. It is also Bell System, T1 compatible and transmits digital stream at a total bit rate of 1.544 Mbit/sec. The system was developed by DCC and AT&T.

FIGURE 6 shows a block diagram of the M/AESTRO system.

standard digital carrier for terrestrial distribution), so the networks first have to encode it to be able to use T1 to carry digital audio to the uplink. For example, NBC will be using two T1 digital circuits for six 15 kHz audio channels each requiring 384 kbit/s and for four 7.5 kHz audio channels, each also 384 kbit/sec.

T1 circuits transmit 1.544 Mbit, which in NBC's case will allow them to transmit additional 8-bit data. A standard T1 radio transmits a digital stream of 1.544 Mbit/s; in NBC's case, 384 kbit/sec X 4 channels + 8 kbit = 1.544 Mbit/s.

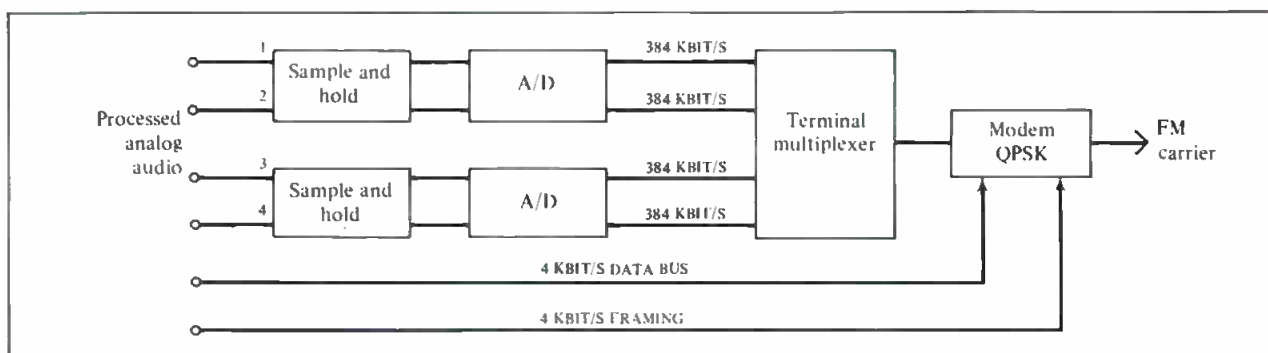

Figure 6. A block diagram of the M/AESTRO system.

Studer Re-States the Art



With the new A810, Studer makes a quantum leap forward in audio recorder technology. Quite simply, it re-states the art of analog audio recording.

By combining traditional Swiss craftsmanship with the latest microprocessor control systems, Studer has engineered an ATR with unprecedented capabilities. All transport functions are totally microprocessor controlled, and all four tape speeds (3.75 to 30 ips) are front-panel selectable. The digital readout gives real time indication (+ or - in hrs, min, and sec) at all speeds, including vari-speed. A zero locate and one autolocate position are always at hand.

That's only the beginning. The A810 also provides three "soft keys" which may be user programmed for a variety of operating features. It's your choice. Three more locate positions. Start locate. Pause. Fader start. Tape dump. Remote ready. Time code enable. You can program your A810 for one specialized application, then re-program it later for another use.

There's more. Electronic alignment of audio parameters (bias, level, EQ) is accomplished via digital pad networks. (Trimpots have been eliminated.) After programming alignments into the A810's memory, you simply push a button to re-align when switching tape formulations.

The A810 also introduces a new generation of audio electronics, with your choice of either transformerless or transformer-balanced in/out cards. Both offer advanced phase compensation circuits for unprecedented phase linearity. The new transport control servo system responds quickly, runs cool, and offers four spooling speeds.

Everything so far is standard. As an option, the A810 offers time-coincident SMPTE code on a center track between stereo audio channels. Separate time code heads ensure audio/code crosstalk rejection of better than 90 dB, while an internal digital delay automatically compensates for the time offset at all speeds. Code and audio always come out together, just like on your 4-track. Except you only pay for 1/4" tape.

If you'd like computer control of all these functions, simply order the optional serial interface. It's compatible with RS232, RS422, and RS422-modified busses.

More features, standard and optional, are available. We suggest you contact your Studer representative for details. Granted, we've packed a lot into one small package, but ultimately you'll find that the Studer A810 is the most versatile, most practical, most *useable* ATR you can buy.

The Swiss wouldn't have it any other way.



STUDER REVOX
PRECISION FROM SWITZERLAND

Studer Revox America, Inc. • 1425 Elm Hill Pike, Nashville, TN 37210 (615) 254-5651
Offices: Los Angeles (213) 780-4234 • New York (212) 255-4462 • Dallas (214) 760-8647 • Canada: Studer Revox Canada, Ltd.

Circle 31 on Reader Service Card

www.americanradiohistory.com

Solid State Logic

In the Foreground of Television Audio

Audio for video is on a lot of minds these days. Advanced video formats and transmission methods make dramatic improvement possible. Producers' concerns over the initial impact and residual value of their programmes make it desirable. EFP, new competitive arenas and increased consumer awareness make it necessary. And now, the SSL Stereo Video System makes it practical.

The SL 6000 E Series places all of the signal processing, switching and machine control required for live and post-production stereo audio under the control of a single engineer. Fully distributed master logic and extensive local switching accommodate the immediacy of broadcast requirements with the versatility of multi-track technology. Exclusive SSL software and a unique mix bus system combine the creative flexibility of film sound technique with the efficiency and economy of electronic production.

The SL 6000 E Series lets you specify a system which will meet your current needs exactly. As those needs grow and change, SSL fills them with additional hardware and software modules which retrofit in the field. The Stereo Video System is designed and built to last. Your investment is further protected by performance specifications which exceed the challenge of the best 16 bit digital recorders.

And of course, the Solid State Logic Stereo Video System provides you with the ergonomic and sonic attributes which have made our companion SL 4000 E Series the leading choice of the world's great music studios.

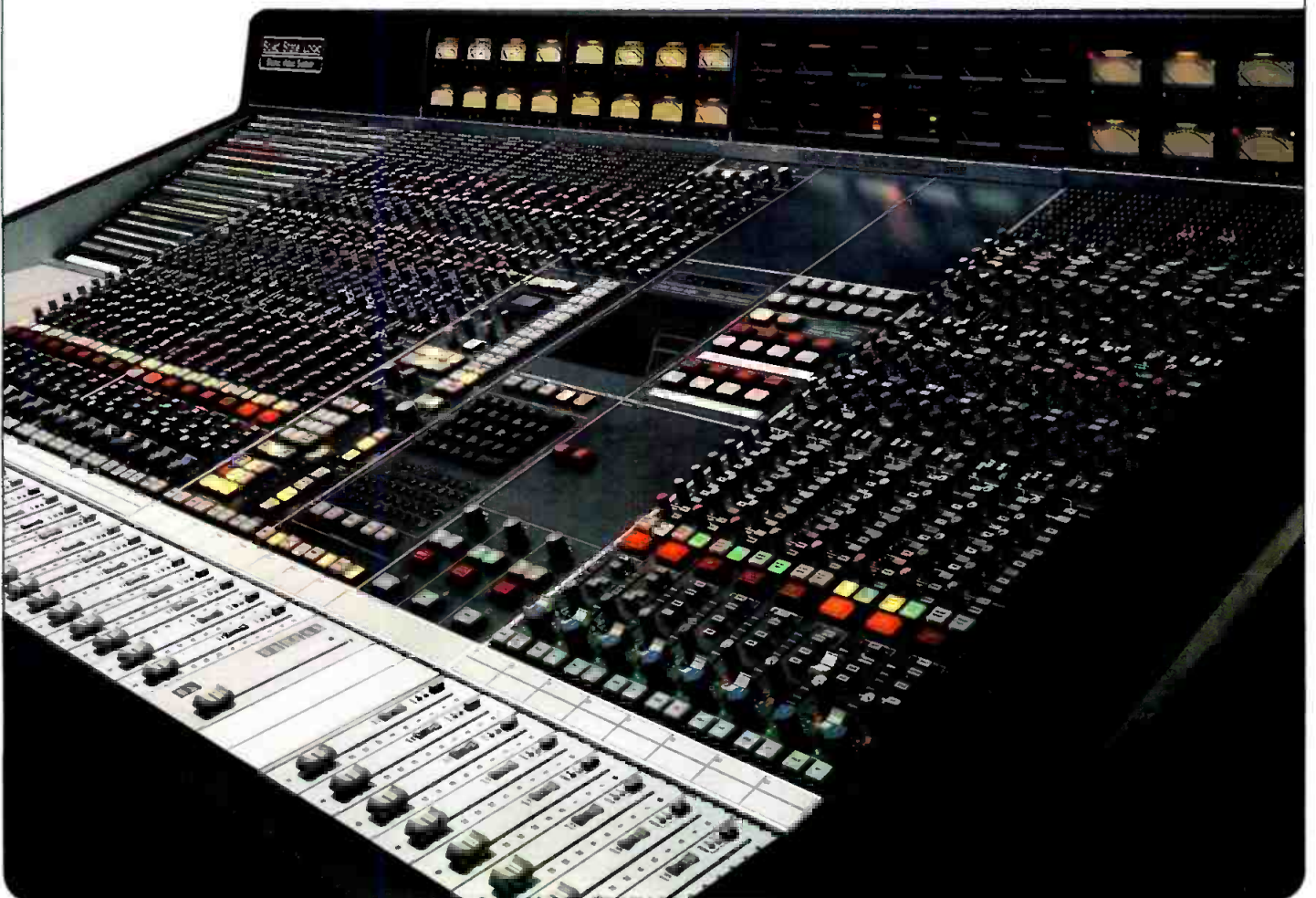

Format Flexibility

The Stereo Video System's six bus mix matrix accommodates all audio-for-video formats. Along with standard mono, stereo and multi-track operations, each input may be panned between one of three stereo mix buses. This allows the engineer to freely divide the console into dialogue, music and effects sections as each project requires.

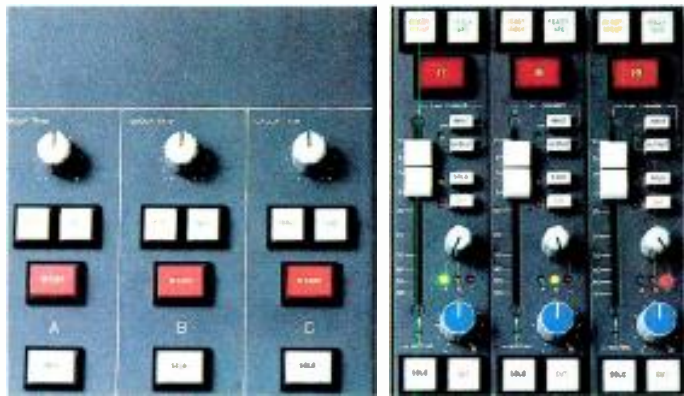

The Dialogue, Music and Effects mixes may be recorded in mono on a 3 stripe or 4 track, or in stereo on an 8 track or the multi-track master. Composite stereo and mono mixes of all 6 buses are derived from the master mix matrix for monitoring, transmission and/or simultaneous (first generation!) layback to the stereo video recorder. Alternatively, the six buses may be used for stereo mix and mix minus feeds during live coverage.

Comprehensive Signal Processing

Each I/O module contains an expander/gate, compressor/limiter, high and low pass filters, four band parametric equalisation, six cue/aux sends and tape electronics remotes. Master logic, push-button signal processor routing, patchfree audio subgrouping, and 8 VCA Group Masters ease complex productions, and always provide the minimum signal path.

Total Recall

Complete details of all I/O module control settings are stored on floppy disc by SSL's Total Recall System, enabling console setups to be restored within .25dB accuracy. Not only does Total Recall save time on each production, it allows greater scheduling flexibility with fewer headaches than ever before possible.

Computer Assistance. Live And In Post.

The SSL Primary Studio Computer is instructed with simple phrases entered via dedicated command keys and an alphanumeric keyboard at the console centre. A small video display advises the engineer of all activity. Above this display, controls for the SSL Video Switcher enable the mixer to call programme, preview or computer displays to the main video monitor.

The computer accepts entries in all timecode and foot/frames standards, and provides complete cue, edit, punch-in and mix list management. In post-production, it links multiple ATRs, VTRs or film chains with the Dynamic Mixing functions, providing fast and familiar rollback and pick-up recording, with every move automatically updated in the computer!



In live production, the SSL Real Time System enables complex sequences of all channel and group fades and cuts to be pre-programmed, and then manually executed with a single set of controls.

The SSL Events Controller provides up to 16 multi-repeatable contact closures under computer control. The SSL Effects Controller adds 40 A/D ports to link the computer with external signal processors.

The Solid State Logic Stereo Video System is available in studio and Outside Broadcast versions from 16 to 56 I/O modules, with up to 112 line and microphone inputs plus four stereo effects returns. Please call or write on your letterhead for complete details and prices.

Solid State Logic

Churchfields, Stonesfield
Oxford, England OX7 2PQ
Telephone (099 389) 8282
Telex 837400 SSL OX

Solid State Logic
Stereo Video Systems

Solid State Logic

2352 Wisconsin Avenue N.W.
Washington, D.C. 20007 USA
Telephone (202) 333-1500
Telex 440519 SSL DC

The VOICE-MATIC™ Automatic Microphone Mixer

**JUST GOT
EVEN
BETTER**

Introducing the LEVEL-MATIC™ module option

The Voice-Matic Model DE-4013 has received wide acceptance in sound reinforcement, broadcasting and teleconferencing applications by eliminating feedback and fading sound levels. With the NEW LEVEL-MATIC master module option, the Voice-Matic is totally automatic.

- Soft talkers receive added gain.
- Loud talkers and background sounds are attenuated.
- A smooth, uniform output level is the result.
- Retrofits all existing DE-4013 mixers.

Once you hear it, you won't want your sound system without one.

Call or write today for more information on how the Voice-Matic mixer with the Level-Matic option can improve your sound installation...automatically!

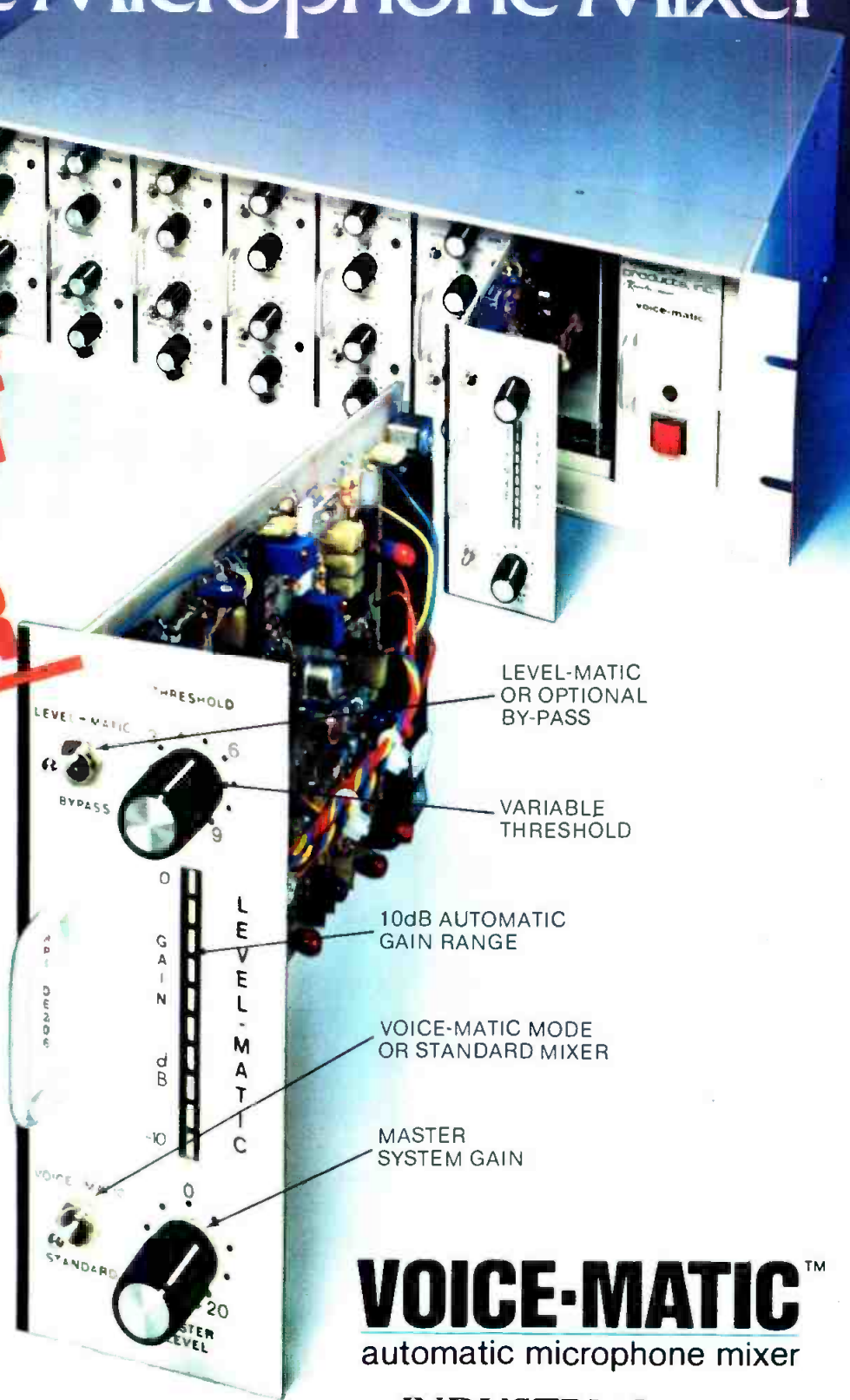

VOICE-MATIC™
automatic microphone mixer

**INDUSTRIAL
RESEARCH
PRODUCTS,
INC.**

A Knowles COMPANY

321 Bond Street • Elk Grove Village, IL 60007
(312) 439-3600

Circle 33 on Reader Service Card

There are two apparent needs which the design of this system helps to satisfy:

- 1) Provide multiple uplink access to a satellite transponder.
- 2) Provide compatibility with Bell System, T1 radio or wire distribution.

The block diagram describes the general principle involved. Processed dual-channel audio is fed to an A/D convertor on a time-sharing basis, and is converted to a digital stream at 32 kHz sample rate and 15-bit quantization per sample; then it is instantaneously compressed to 11 bits and a parity bit is added, bringing it to a total of 12 bits. This means that total bit rate for each channel is 384 kbit/sec (32 kHz × 12 bits). As four channels are multiplexed, the total bit stream becomes 1.536 Mbit/sec, which become 1.544 Mbit/sec with the addition of 4 kbit/sec of framing codes and 4 Kbit of data. 1.544 Mbit/sec is the standard for T1 carriers.

Forward Error Correction (FEC) is applied to the resulting data stream at 1/2 rate, so the transmitted data rate is doubled and is 3.088 Mbit/sec. Under QPSK this signal is modulated at a ratio of 1 bit/Hz, so the necessary occupied bandwidth for the carrier is 3.088 MHz.

On the receiving side the data stream is decoded with a so-called "soft decision," time-dependent decoder, whose general principle could be described as a combination of the system used by DATE and ADDS. The system is claimed to provide BER of 10^{-7} .

M/AESTRO is capable of originating five carriers containing four 15 kHz audio channels each from different uplinks. A total of twenty 15 kHz channels or a combination of voice and data channels can be transmitted on one transponder.

The three digital systems described above are designed to be used either on a C-band satellite transponder or with terrestrial microwave transmission.

Despite some similarities which are explained by virtue of the application, the Sony System (point-to-multipoint satellite distribution of audio) is quite different because it is operating on the Ku band. The system is designed to place 12 dual 15 kHz channels at either the 12 or the 14 GHz band.

FIGURE 7 shows a block diagram of the Sony system. Similar to the three systems described above, the Sony system uses the PCM format with a 32 kHz sampling rate and 14-bit quantization per sample; the similarity ends there. 15 additional bits are added to the original 28 bits (14 + 14 for dual channel) for error correction, two bits for housekeeping or service (SB) and 3 bits are added for synchronization. Therefore, the total digital word for one dual channel is 48 bits (14 + 14 + 15 + 2 + 3), which brings the total data stream rate of one dual channel to 1.536 Mbit/sec. For a 12 channel system, this becomes 18.432 Mbit/sec.

As can be seen from FIGURE 7, twelve dual channels are multiplexed by Time Division Multiplexing (TDM). This

places each bit of the channels in sequential order, which means that when a channel is selected on the receive side, only one bit out of the total 12 needs to be selected at a given time. This is possible providing that bursts with errors at the transmission side are less than 12 bits.

The digital stream is QPSK modulated at ratio of 1 bit/1 Hz. It's occupied bandwidth is 18.432 MHz, which requires the entire transponder on a satellite. Bit Error Rate (BER) is maximum 10^{-4} and is improved under the error correction scheme. The error correction method which is chosen for this system reflects the interrelation between minimum allowable carrier-to-noise ratio (C/N) versus a maximum allowable number of lost bits.

A C/N of about 6 dB corresponds to about one click a second and is considered unacceptable, which in this case corresponds to a 10^{-2} condition. At 7 dB, C/N clicks are not present. This corresponds to about 2-3 bits error. A C/N of about 12 dB could cause 1 bit of error in a period of about 3-5 sec, and 13 dB of C/N presents no detectable error.

It is interesting to note that this system does not use digital companding techniques, which helped in the other cases to achieve an acceptable C/N. In this case the error correction is assigned to each dual channel, rather than to the resulting data stream. Digital words are combined into frames, each containing 14 words of 48 bits each. 12 bits of each of the words are actually redundancy bits and are able to restore the word completely if the error is less than 2 bits per word; in case it is 3 bits per word, a parity bit allows the restoration—providing that the errors are better than one word per frame. If the errors are even greater than that, the output signal is muted.

The system is capable of transmitting 24 mono or 12 dual 15 kHz audio channels or a greater number of combinations of 7.5 kHz voice channels or data channels. Similar to ADDS system, it does not provide multiple uplink access to a satellite.

A big advantage of the system is its ability to transmit on the Ku-band, which does not require a big 10-12 foot antenna on the receiving side (as is the case with the systems using the C-band transponders). A 2-3 foot antenna is considered adequate for reliable reception (minimum C/N = 7 dB), which in the future might make this or a similar system a tool for direct broadcast to homes.

OVERVIEW

While digital broadcasting offers the audio signal a define immunity to the usual analog transmission diseases, the resulting audio is only as good as the analog source at the transmission side or the analog system for its distribution at the receive side. Regardless of the mode of transmission, the audio equipment at the transmission side is analog. On the receiving side a demodulated signal is normally retrans-

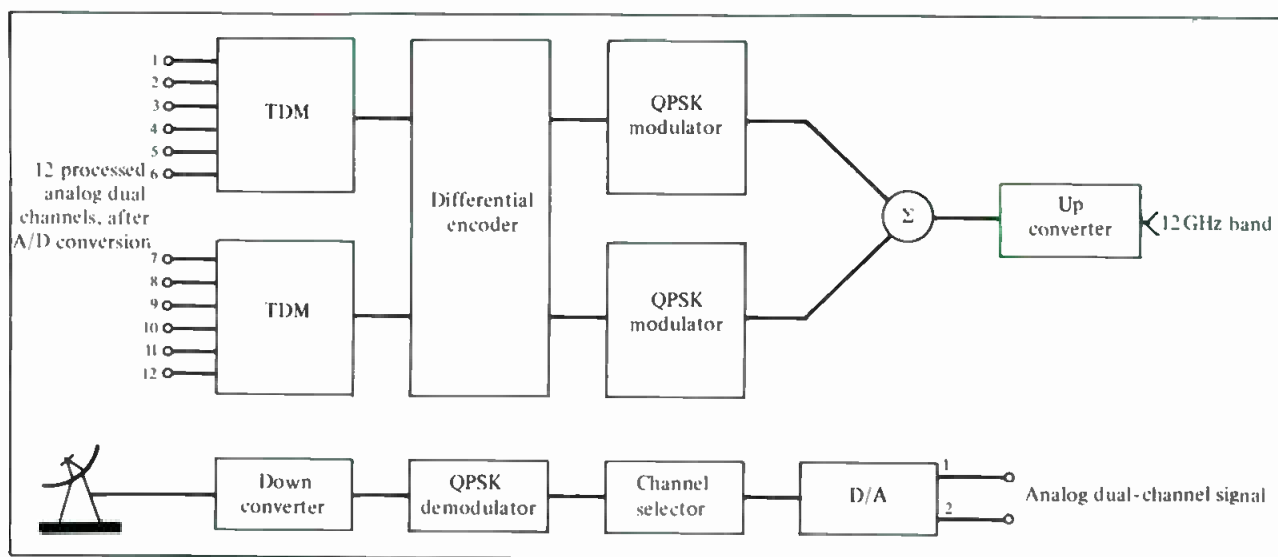
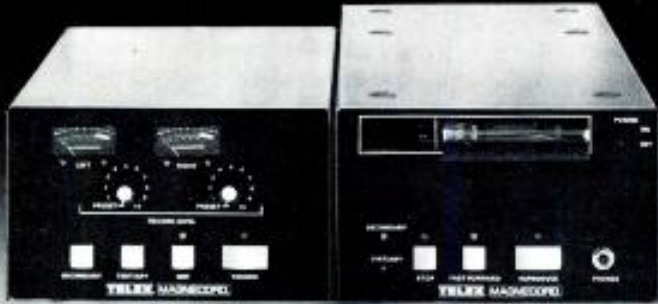

Figure 7. A block diagram of the SONY system.

MAGNECORD MC-II

Compare Quality at this Price



Incomparable
from \$1100.00*

- Meets or exceeds NAB standards, with IEC equalization on request.
- DC servo, flutter-filter drive runs true regardless of line voltage fluctuation.
- Cool operation; no ventilation required.
- Full remote capability.
- Long life heads and phase locked tape guides.
- Mono or stereo play models field convertible to record.
- Automation cue tones (stop, secondary, tertiary) with LED's and external switching contacts.
- Cue track access for FSK logging.
- Universal mic/line input.
- Immune to RFI and EMI.
- Rugged design in the Magnecord tradition —made in USA.

*Suggested Pro Net Price

Quality Products for the Audio Professional

TELEX MAGNECORD

TELEX COMMUNICATIONS, INC.

9600 Aldrich Ave. So. Minneapolis, MN 55420 U.S.A.
Europe: Le Bonaparte - Office 711 Centre Affaires Paris Nord 93153 Le Blanc Mesnil France

Circle 16 on Reader Service Card

mitted to the final customers. Of course, digitized audio has to be converted back to analog before retransmission. There is a big difference in terms of programming between centrally and locally originated material. In many cases a satellite signal from a central source should be tailored for the local retransmission. One of the desirable ways to do this is to record the transmission and then release it as convenient for broadcasting. If the transmission offers digitized audio, it is only logical to record it digitally without losses.

Unfortunately, no digital recording/reproduction hardware is presently available that is compatible with the systems for broadcasting. The major differences are in the coding of formats—in most cases a combination of sampling frequency and quantization per sample. There are no standards established on the interface between digital recording and broadcasting.

The Digital Audio Technical Committee, which is expected to develop the standard, has just published a report on the proposed digital parameters and operational alternatives for the recording industry. It was assumed that professional digital audio should accommodate a bandwidth of 20 kHz, with a sampling rate of about 50 kHz and quantization per sample of 16 bits, expandable to 18 bits. The 32 kHz rate used by the four networks in the U.S. and by the members of EBU in Europe is not adequate; it does not make the minimum required 40 kHz Nyquist frequency for 20 kHz audio bandwidth; it is also not a multiple of 600 Hz, which should be the case if a 16-bit sample rate is adapted. (This is necessary to avoid interference with a frequency vital to NTSC color television broadcasting.)

The frequencies which are considered for a standard sample rate are 44.1 kHz, 45 kHz; 48 kHz; 50 kHz; 50.4 kHz; 52.5 kHz; 54 kHz and a few others. A strong candidate is 48 kHz, which is currently used by the DEC in Europe.

Some progress, however, has been made in the area of recognizing a need for the sample rate transformation from one "standard" to another.

For example, Studer Revox came up with a two-channel digital audio sampling frequency converter. It converts the sample ratio of 32 kHz to 48 kHz and vice versa; it also deals with "non-trivial" frequencies like 44.1 kHz. However, it uses 16 bits quantization per sample as a base, which does not help the broadcasting industry. At the moment, no hardware for interfacing digital broadcasting with digital recording is available or is known to be under development.

This raises a question of validity of digital broadcasting of audio as opposed to analog.

Some recently developed analog systems for broadcasting offer a comparable and in some instances better performance than is found in digital transmission. These analog systems are considerably less expensive.

On the other hand, hopes exist that fast proliferation of broadcasting digital standards will move digital hardware researchers and manufacturers towards resolution of the standards that obviously have to be a compromise, or towards developing a universal converter which will serve virtually the same purpose. ■

BIBLIOGRAPHY

1. Lagedec, R., et al. "A Two-Channel Professional Digital Audio Sampling Frequency Converter," AES Preprint 1882 (March, 1982).
2. Nakajima, H., et al. "Satellite Broadcasting System for Digital Audio," AES Preprint 1855 (October, 1981).
3. Salamoff, S. F. "The DATE System: Program Audio Via Existing Video Transmission Facilities," *SMPTE Journal*, vol. 88, no. 6, June, 1979.
4. Schreiner, Peter. "Digital Audio for Radio Network Satellite Distribution Systems," AES Preprint 1936 (October, 1982).
5. Talbot, D. "A Satellite Communication, Broadcast Quality Amplitude Compander," AES Preprint 1481 (May, 1979).
6. Taylor, John. "Will Satellite Channels Meet TV Needs?," *Television/Radio Age*, Sept., 1980.

Automated Audio Test Systems For Professional Audio Performance Requirements

Can you afford not to automate your audio testing?

AUTOMATED AUDIO TESTING CONCEPTS

AN AUTOMATED, SOFTWARE-CONFIGURABLE test system normally consists of a number of computer-controllable (programmable) instruments, a computer, peripherals such as hard copy units and disc storage, perhaps some signal switching or interface circuitry to help control the device under test, and software to make the whole thing run (see FIGURE 1). For professional audio applications, the instruments would need to consist of harmonic and intermodulation distortion analyzers, low distortion oscillators, level meters, and perhaps frequency counters, phase meters, and waveform analyzers. The hard-copy peripherals would need graphics capabilities for most audio workers, and the signal switchers would need to be compatible with the balanced, low noise, low distortion world of audio.

The benefits of automation are generally well known—faster testing, fast and low-cost printed documentation (FIGURES 2 and 3), operability by people with little technical skill, consistent procedures from day to day and from operator to operator, and the ability to test devices or systems which are too complex to be thoroughly tested by manual means. Of course, these benefits have their price; automated test systems cost more than simpler manual test equipment.

Bob Metzler is Engineering Manager, General Purpose Instruments at Tektronix.

This article will examine some of the unique things automated systems can do in typical pro audio environments, take a look at the up-front costs, and analyze the potential long-term savings.

APPLICATIONS IN OPERATING AND MAINTENANCE ENVIRONMENTS

Audio workers in maintenance roles in recording and broadcasting are often stretched pretty thin. They are expected to keep up a wide variety of operating equipment, install and verify the performance of newly-purchased gear, and sometimes do custom modification, design, or construction. The cost of downtime in a large recording studio or broadcast station is quite high. Regular performance tests of the system can be extremely valuable in pinpointing trends before catastrophic failure occurs, but the tedium of doing those tests plus all the other pressures on the engineer's time make it easy to postpone them or to do them casually. An automatic test system can totally relieve the engineer from routine tests, freeing him or her for the things that aren't automatable (yet!). Pressing a button before you head home after an all-night session can yield a set of graphs or a magnetically-logged set of data when you come in the next morning that completely characterize the performance of all channels of the system. An automated test system would permit the quality-conscious broadcast station to run an audio proof every night at sign-off. In less than two minutes, distortion and frequency response at seven frequencies at each of three modulation levels can be obtained and plotted

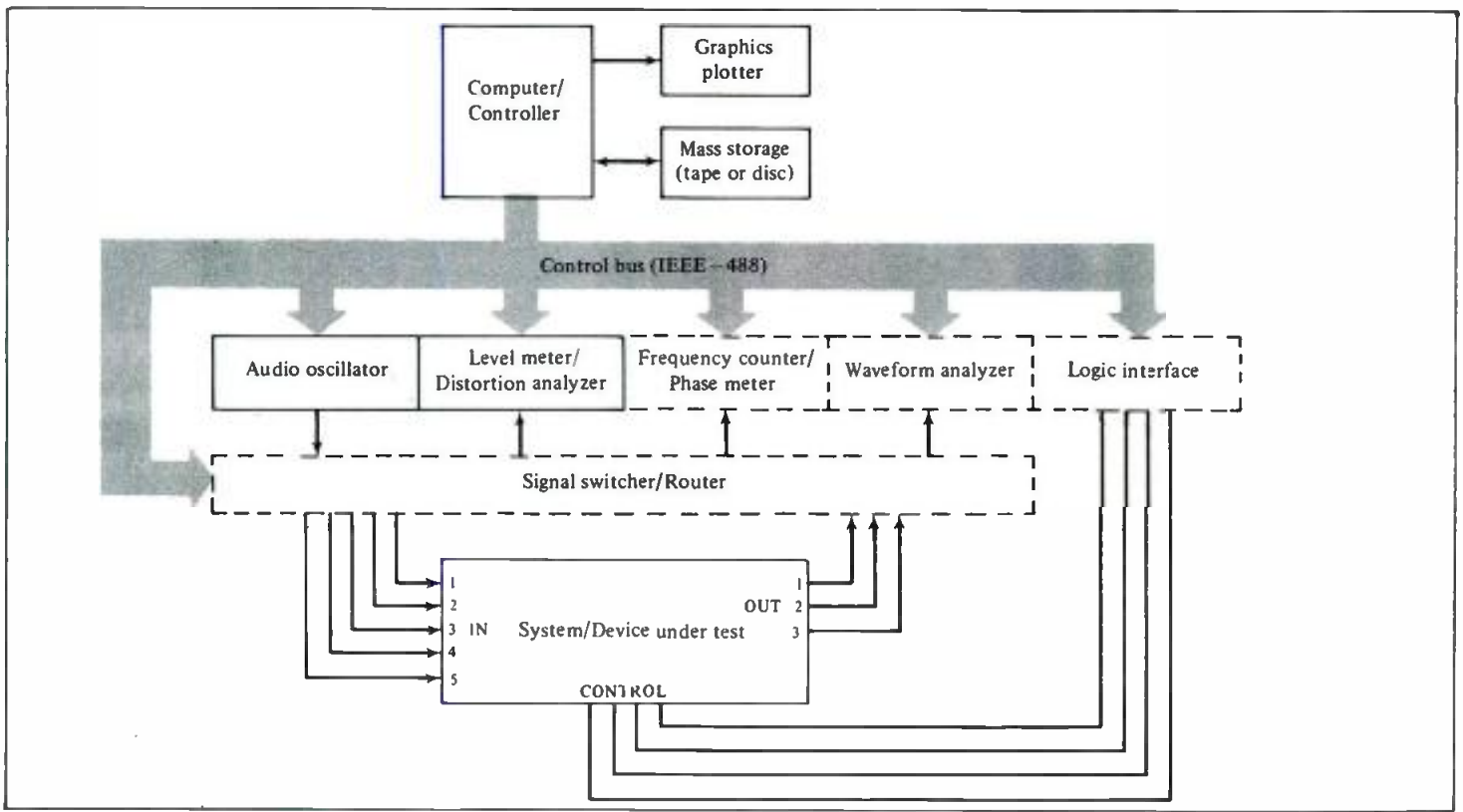

Figure 1. Block diagram of a typical automated audio test system. Items shown dashed are optional, depending on the particular application.

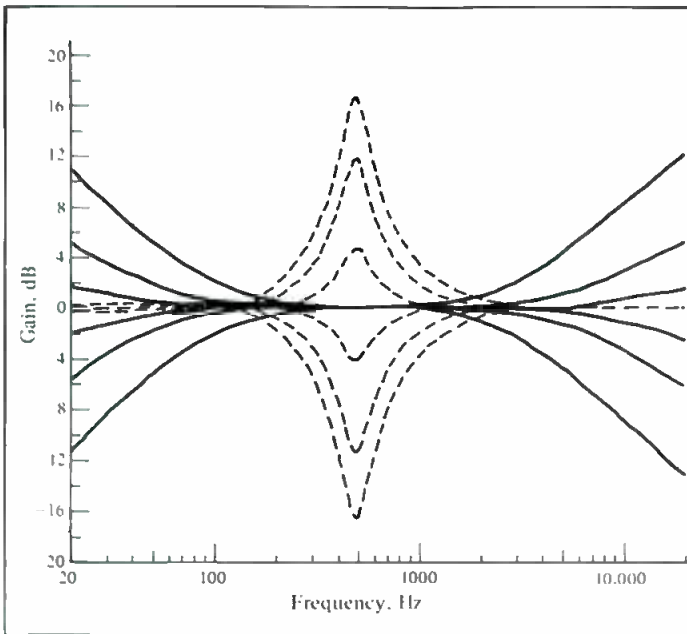

Figure 2. Sample system-generated frequency response curves of several settings of a parametric equalizer. This entire family of curves was measured and drawn in about 180 seconds.

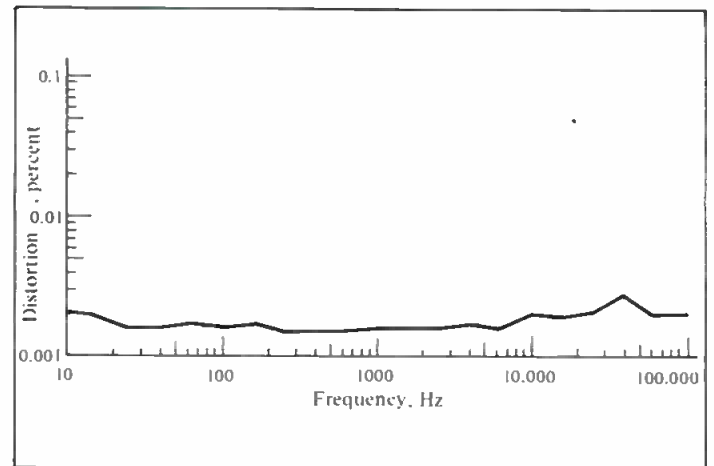

Figure 3. Level and harmonic distortion curves of a "straight piece of wire," showing typical residual levels of the SG 5010 Programmable Audio Oscillator and the AA 5001 Programmable Distortion Analyzer. This data taking and graphing across four decades with five measurement points per decade took 77 seconds.

for documentation, and the test system won't make mistakes even though it's two a.m. and the engineer is tired!

Speed, documentation, and eliminating tedium aren't the only benefits of an automated system to the maintenance or operating engineer. In larger operations, many items of equipment are simply too complex to be adequately tested by manual means—either when they're unpacked from the shipping crates or at some later date. A fifty-by-fifty audio switcher or a large recording console with dozens of channels, each with equalizers and effects, is just not practical to thoroughly test by hand. Performance problems in a rarely-used channel may be discovered only when the

performance is critically needed, and long after the system is out of warranty. An automated system can grind through noise, distortion, and frequency response tests of every crosspoint or every channel—potentially thousands or tens of thousands of individual measurements—even if it takes all night, and present you with the data the next morning.

An automated test system in broadcast applications need not all be at the same location. A data communications interface, such as an RS-232 adapter and modem, plus either dial-up or dedicated telephone lines, can link a distortion analyzer at the transmitter to the remainder of the system at the studio. Regular automated testing lets you see if you're

An Automated Test System Overview

Tek's new SG 5010 Programmable Audio Oscillator is a brand-new design covering the 10 Hz to 163.8 kHz spectrum. It includes a state-variable oscillator circuit for -100 dB (0.001 percent) maximum distortion from 20 Hz to 20 kHz, a crystal-referenced frequency synthesizer for 0.01 percent accuracy and stability, and a readout with four digit resolution. The SG 5010 produces over 21 volts open circuit from program-selectable source impedances of either 600, 150, or 50 ohms; it therefore can deliver more than +28 dBm to 600 ohm loads and more than +30 dBm to 150 ohms. Amplitude resolution is 0.05 dB. The output is program-selectable as either fully floating or ground-referenced and either balanced or single-ended. SMPTE/DIN intermodulation signals are produced in either 4:1 or 1:1 amplitude ratios, with the lower frequency selectable among 40, 50, 60, 80, 100, 125, 250, or 500 Hz. The upper frequency is fully programmable to the 163.8 kHz upper limit of the oscillator. The CCIF twin-tone IMD signal is generated by the SG 5010 with spacings between the two tones of twice the SMPTE/DIN lower frequency choices listed above, and any center frequency from 3 kHz to 163.8 kHz. Square waves can be generated between 10 Hz and 16.38 kHz. The output can be steady state or a repetitive burst, with the number of cycles ON and OFF in the burst individually programmable from 1 to 65,535. Built-in frequency sweep is available, with the start and stop frequencies, time per step, number of steps, and linear or logarithmic sweeps all programmable; the sweep function also works in IMD and squarewave modes. Amplitude sweep with similar programmability is also available. All parameters—frequency, amplitude (volts or dBm), burst cycles, sweep steps, etc.—are digitally displayable on the instrument front panel. An amplifier mode lets the SG 5010 high-level, balanced, multiple impedance output circuitry and attenuators be used with any external input signal.

The AA 5001 Programmable Distortion Analyzer is based upon the successful design of Tek's AA 501 Analyzer first introduced three years ago, plus numerous refinements, improvements, and the necessary circuitry for programmability. Harmonic distortion, IMD (SMPTE/DIN/CCIF difference tone) down to 60 millivolts, and level capability from 200 volts to 3 microvolts are featured. Detector response may be program-selected between true rms and average-responding. Four built-in filters and any external filter may be programmed. Typical residual distortion levels are 0.0012 percent to 0.002 percent. Measurement speed is typically less than 2 seconds for level, noise, and IMD measurements and 2 to 4 seconds for THD measurements.

Since the SG 5010 and AA 5001 are separate plug-in modules in the TM 5000 series, they need not always be used in pairs. For testing tape or disc players with a pre-recorded source, no oscillator need be purchased. Multiple oscillators or multiple analyzers can be combined in one mainframe when the application requires. Other instruments, like a universal counter for phase measurements, may be added to complete the test system.

getting the quality you're paying for in those expensive equalized program circuits. As an example of current trends, sub-group T-4 of the European Broadcasting Union has recently completed recommendation R27, covering just such applications, and describing equipment and techniques to permit rapid, automatic characterization of program channels before special broadcasts without the expensive additional line rental time to adequately check quality with manual techniques.

APPLICATIONS IN PRODUCTION TEST ENGINEERING

The Production Test Engineer for an audio equipment manufacturer has a whole different set of problems. He needs high testing throughout to keep up with production quantities with a minimum number of people and test stations; he may be using semi-skilled workers for testing procedures, both to save money on labor and because he needs to dedicate those rare skilled technicians he does have to more difficult tasks like troubleshooting; he is responsible for maintaining the quality of product output, meaning he has to be sure no tests are skipped and that standards are interpreted rigorously and consistently from day to day and operator to operator.

An automated test system perfectly fits the needs of almost every production test operation. It is easy to justify financially—even to an economy-minded management—due to the large reductions in expense it can produce. Typical audio tests can be performed five to ten times faster with an automated system than by manual techniques. Thus, one automated system can do the work of five to ten manually-equipped benches. This alone easily justifies the cost. Payback will repeat over and over due to the wage savings from the four to nine technicians who can shift to other, higher needs. Interestingly, many companies choose not to exploit all of the speed advantages of automation, but instead typically test more parameters under more conditions of amplitude and frequency to obtain a higher confidence in the quality of their product—a fine example of having your cake and eating it too. Additional value comes in using the test data statistically to help control the up-stream production processes, to monitor vendor component quality, and to produce a higher yield of units which meet standards the first time through.

Since a production test station can be configured around a simple, "execute-only" controller, and the procedures are all resident in the software, the operator need not be a skilled technician. Making connections to the device under test, plus any necessary settings on the device itself, is typically all that is required of the operator. Thus, the savings in wages by using semi-skilled assembly class workers instead of technicians also contributes to the savings obtainable via an automated system.

THE SYSTEM IN THE DEVELOPMENT LABORATORY

Taking data, and converting it to graphic formats for interpretation, is a necessary part of all research, development, and design activities. Performance testing of a new prototype, and then assuring that it still works well under the required environmental conditions and with a realistic tolerance range of components, seems to occupy more designer time than actual design itself. The repetitious nature of that "dogwork" usually means that it is not done as thoroughly as it should be. An automated test system can make the measurements and portray them in the desired graphic formats for quick interpretation by the engineer. It can do this unattended, freeing the engineer for more creative work. The ease of collecting and presenting data by a

system encourages the designer to explore more thoroughly, rather than gloss over some of the finer points. Given that the system has the basic features and performance levels which the application requires, it serves as a powerful multiplier of the design engineer's output. As the shortage of talented design engineers becomes greater, their salaries higher, and the concern for product manufacturability and quality greater, the need for automated systems in the lab will become more self-evident.

AND NOW, THE BOTTOM LINE

Let's start with some approximate comparisons of the cost of automated test systems versus manually-operated test equipment which could make the same measurements. A reputable conventional audio oscillator and harmonic distortion analyzer/level meter combination with specs adequate for today's high-quality professional and consumer audio equipment will sell in the \$2500 to \$3500 price range. Adding intermodulation distortion measurement capability will bump that into the \$3300 to \$4500 range.

That same level of capability, including intermodulation distortion measurement capacity, will cost about \$8000 with a programmable audio oscillator and a programmable distortion analyzer. An IEEE-488 controller to tell the instruments what to do will add another \$3500 to \$12,000, depending on factors such as built-in display and mass storage, amount of memory, number of communications ports, and so forth. Outboard disc storage, often required in the data-intensive production test world, can add from \$2000 to \$10,000 more. Simple alphanumeric printers can be had for well below \$1000, but graphics-capable hardcopy units or pen plotters are several thousand dollars above that. Switchers, to allow totally automatic testing of multi-input and multi-output devices, add to the cost as do digital interfaces to permit control of logic-controlled consoles, tape machines, and similar devices under test. A typical range for a complete system including the instruments, an average controller with graphics capability plus a graphics hardcopy peripheral, and adequate mass storage for programs and data, is in the \$20,000 to \$25,000 ballpark.

So you ask: "Why in the world should I pay \$25,000 for an automatic audio test system?" Consider the labor costs saved because of the speed of automation. Level measurements, including power and noise or signal-to-noise, can be made by the system described in about two seconds per point. An intermodulation distortion or harmonic distortion measurement to instrumental residual levels will be made in three to four seconds. For example, an audio device could be characterized for frequency response and harmonic distortion at ten different frequencies from 20 Hz to 20 kHz, plus intermodulation distortion and a signal-to-noise measurement, in about fifty seconds—and that includes drawing a graph of the results! Simply taking and recording the same data with even the fastest, most automatic non-systems instruments would require at least three to four minutes before you even start looking for the graph paper. With even modest requirements for written documentation and a few operator mistakes (which the system won't make), a time savings of from five-to-one up to ten-to-one is typical.

Now, let's see what that time savings amounts to in dollars. Depending on the salaries involved and your company's overhead (burden) structure, the fully burdened real cost of technicians and junior engineers probably runs from \$30,000 to \$60,000 per year. If we use a five-to-one time savings to keep things conservative, the speed advantage of a system can cut 80 percent off your present test labor costs. A moderate-volume manufacturer with five full-time technicians doing production testing could replace them with one system and a semi-skilled operator, at an annual labor and burden expense saving of at least \$125,000.

Since you may not have five full-time test technicians, let's make some marginal estimates to see at what level it's worth giving serious consideration to an automated system. Most corporate financial controllers in these difficult and

uncertain times like to see a capital investment pay off within a relatively short period, say two to three years. If we use the average \$25,000 system discussed above and contrast it to an average \$4,000 manually-operated oscillator/analyzer of similar measurement capabilities, we have a \$21,000 differential investment that we will want to repay within two or three years in labor cost savings. Using the same 80 percent cost reduction just discussed (due to the five times speed increase), we can pay back the \$21,000 differential in two years if we're now spending about \$26,000 or more every two years (\$13,000 per year) in fully burdened testing labor costs. At typical burdened rates of \$30,000 to \$60,000 per person per year, if you have an equivalent of from one-fourth to one-half a full-time person engaged in routine performance testing, you should seriously consider the advantages of an automated system. A more accurate estimate requires knowledge of your own labor and overhead rates and amount and type of testing, but the analysis is probably worthwhile if your organization has more than ten person-hours per week, on the average, involved in testing. Other less tangible considerations, such as product quality or the difficulty of

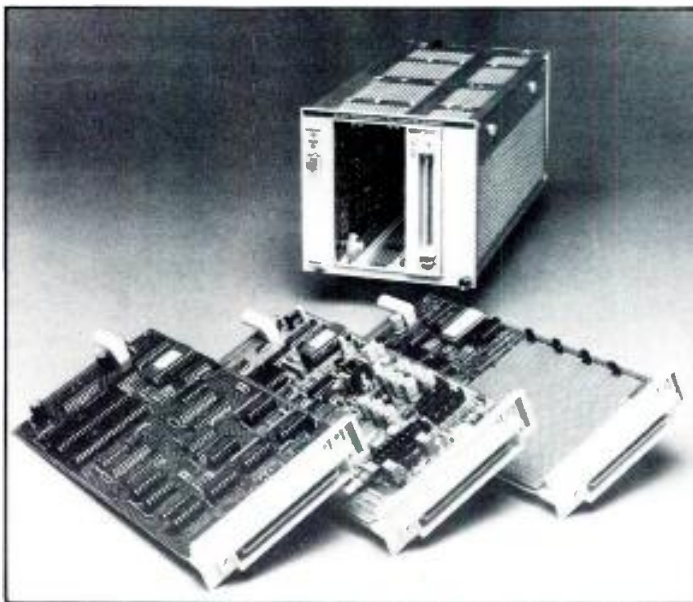

Figure 4. Three examples of interfacing cards for the TM 5000 system, plus the MI 5010 Multifunction Interface which houses them. Card functions include relay scanner/switchers, digital input/output, digital-to-analog conversion, and a half-blank development card to provide simple control of custom circuitry over the IEEE-488 bus or custom interface to the bus.

finding another qualified person if your work load is just at the level where you need to hire, will also affect the decision.

Economic "proof" of the payback of a test system is usually more difficult in the design engineering environment than in maintenance or producing testing, just as proof of payback is difficult for computers, microprocessor development equipment, laboratory-grade test equipment, and other design engineering tools. The return for the up-front cost comes in the form of design quality, manufacturability, immunity to environmental variations, and in the productivity and morale of the designer himself. These concepts are, of course, notoriously difficult to quantify—yet are absolutely critical to the survival of development-based industries in increasingly competitive times.

If the concepts of automation are appealing, but the whole capital amount cannot be financed right now, consider some "phased entry" strategies. A low-distortion programmable oscillator can be operated without a computer/controller for many common applications; it can do a software (stepped) "sweep" between any selected frequencies with selectable

Audio Automation Ain't Easy!

In times when a good deal of electronic technology is charging off somewhere between microwaves and visible light, it's tempting to oversimplify the technical challenges in the under-20 kHz world of audio. And, if one-percent distortion and 50 dB signal-to-noise is acceptable performance, there's not much problem in making either manual or automatic audio measurements. However, at the -90 dB to -100 dB (0.003 percent to 0.001 percent) distortion and noise levels that much of today's professional and consumer equipment (and 16-bit digital recording systems) are capable of, audio test equipment design is a real challenge. Even many passive components—resistors and capacitors—prove to have non-linearities that prevent their use at those performance levels. The active, variable devices typically required to provide computer-controllability of instrument modes and parameters are even more of a problem. Low-noise circuitry, which will not mask low residual distortion, is not very compatible with microprocessors, large amounts of logic circuitry, and multiplexed digital displays in the same box. Highly accurate, high-resolution frequency synthesizers and super-low-distortion state-variable oscillator circuits are two different breeds, and combining them without losing either attribute is difficult. The balanced attenuator designs required for true balanced, floating outputs require more complex programmable switching. Low impedance attenuators, such as fifty-ohm circuits to be useful in most European voltage-source professional audio installations, are also difficult to implement without serious compromises. FET switches are attractively compared to relays from a space and cost standpoint, but their use in many critical areas requires design expertise and thoroughness beyond the ordinary, unless it is acceptable to have performance levels which vary widely with changes in ambient temperature and signal level. The multiple oscillators required for generation of intermodulation distortion test signals add to the difficulty of programmable instrument design—but modern trends toward IMD measurements require the capability in any fully-flexible piece of test equipment. Meeting all these conflicting constraints and requirements in the compact package size of Tektronix TM 5000 instruments was a challenge well met by the design team members who include Bruce Hofer, Rich Cabot, Fred Armentrout, and Bob Wright. Their innovative work will be discussed in more detail in future technical publications, and the results will be appreciated by members of the professional audio community.

step time, number of steps, and in a logarithmic or linear sweep. Amplitude sweep capability is also built into the oscillator, as is the ability to store up to ten user-definable setups and then select among them instantly. Thus, a combination of oscillator, analyzer, and an analog X-Y plotter or storage oscilloscope could produce graphs of frequency response and distortion versus frequency or amplitude automatically and rapidly for about \$9,000—without requiring a controller, peripherals, or any software effort. If you already own a plotter, storage scope, or distortion analyzer, the initial investment would be much less. The system could later be upgraded to full automation for even more complex tests by the addition of a controller

and any appropriate peripherals. Several of the personal computers now in use at many audio companies can control IEEE-488 instruments, and thus could do double duty as automated system controllers. The instruments are also fully operable from their front panels in conventional fashion for unstructured, non-repetitive testing.

CUSTOM-CONFIGURING A SYSTEM TO YOUR REQUIREMENTS

While the measurement capabilities of the programmable test instruments cover nearly all standard as well as many unusual audio tests, every application tends to have its unique characteristics. Hardware customizing of an audio test setup may be simplified by assembling a system using modular test instruments. These may include digital multimeters, dc power supplies, universal counter/timers, function generators, relay switchers, and interface devices to both digital and analog worlds. A switcher, for example, can route the oscillator output to multiple inputs of a console or tape recorder and route multiple outputs of the device being tested to the analyzer. A logic-level interface device, via a custom test connector, could control the modes and functions of a logic-controlled console or tape machine.

In the systems control and peripheral area, customizing includes choosing among crt-based controllers with standard high-resolution graphics or a more production-test-environment-optimized controller available in an execute-only configuration with a non-intimidating simple keypad, LED display for operator prompting, and built-in printer for generation of error tags or tabular test data. Graphics peripheral choices include monochrome or color crt displays and graphics plotters with eight-color capability. Mass storage choices for programs and test data range through tape, floppy discs, and hard discs. Networking capabilities permit a test system to be linked into a host or management computer for program download or transmission of test results for later statistical processing and process control or other management uses.

Usually, software is customizable for any application. Demo software and examples of typical audio test routines are readily available for starters, and the high-level "engineering English" commands of most state-of-the-art instruments make program modification and generation simple and self-documenting. Standard graphics software will quickly graph test data in a variety of selectable formats. Software and controller loads may be further reduced by intelligence built into microprocessor-based oscillators and analyzers. Frequency and/or amplitude sweep capability of the oscillator will contribute to program simplicity. Similarly, analyzer firmware will include a settling algorithm (with programmable tolerance limits) which can be invoked to prevent the analyzer from sending data until its reading is settled following any change in frequency, amplitude, or the device under test. The controller thus "knows" that data received from the analyzer is stable, without requiring the user to generate software routines in the controller to test that data.

AND IN CONCLUSION...

Audio test automation, with features and performance levels commensurate with professional and high-quality consumer equipment requirements, is finally here. Audio testing has been one of the last electronic test and measurement application areas to be automated, largely due to some very difficult technical challenges which had to be overcome in order to combine programmability with the performance required by today's best audio equipment. Now that high-performance programmable audio test gear is available, many applications in maintenance, production test, research, design, and development have the opportunity to move from their labor-intensive traditions to more productive, less expensive automated solutions which can also aid product quality and easily provide appropriate documentation. ■

Designing Audio For Video

Editel is one company that has decided to do something about changing the image of sound mixing for video.

THE RECENT INTEREST in the audio-for-video field is due in part to the potential that exists for high-quality audio on cable TV, video disc and network television, since stereo broadcast seems imminent. The poor showing of the record business for the past several years has also forced recording studios to consider new areas of business. Video producers and videotape facilities realize they must be prepared for stereo; existing equipment may have to be modified or expanded, but more significantly, sound tracks will be more closely scrutinized than is now the case in television. Sound mixing for video has existed for many years, on a small scale, producing high-quality mono sound for broadcast and some stereo material for video-cassette and simulcast. It has, however, never gained complete acceptance as an alternative to the recording studio or film mixing theatre.

One company that wanted to change that situation was Editel New York, one of the largest videotape post-production facilities in the country (until recently known as EUE Video Services). In early 1982, they asked me to design a sound mixing facility not only to handle the sound work needed by their clientele—they edit commercials, industrials, entertainment programming—but also to position themselves more strongly in the emerging video markets. The various methods of mixing sound were examined at preliminary meetings—multiple mag machines, multi-track machines and hybrids using both formats. It was decided that the multi-track approach offered the most flexibility and would be capable of the widest range of projects. It would also be the most appealing to music producers, who were likely to be frequent customers. At that point, before

Vin Gizzi is an audio consultant and designer working out of NYC.

considering structural and acoustical design, I had to look closely at the process of mixing sound for video—its strengths and weaknesses.

SHORTCOMINGS

One shortcoming of the audio-for-video field—and a major source of confusion to the average client—is the lack of universally accepted formats. When preparing sound tracks for film, separate 35 mm (or occasionally 16 mm) elements are edited and lined up to picture, then mixed down to a multi-track full-coat from which composite stripe copies are made for release or transfer. A customer can walk into any film facility in the country with these elements and feel reasonably confident that they will be played back at the correct speed and with correct equalization. Numerous support facilities are capable of making transfers to and from mag, and film editors and mixers are generally quite skillful in managing the preparation and mixing of mag tracks. There is a similar standardization within the recording industry, but here the tapes are 15 or 30 ips multi-tracks, or two tracks on quarter- or half-inch tape. Most studios can play audio tapes recorded elsewhere without much difficulty. In the video world, however, there is little standardization of audio elements. While a number of facilities use 24-track 2-inch as a playback standard, many broadcasters run 16-track. Smaller video facilities often are only capable of 8- or 4-track. Clients may be asked to supply mix elements on ½-inch or ¼-inch with 60 Hz sync or SMPTE code; some facilities will even ask for neo-Pilotone sync. Audio carts are a convenient medium for sound effects loops and short cues, but few studios have players on hand, and even fewer have the capability of recording them.

Mix-down formats are no less standardized. A 3-track split (voice, music, sound effects) allows great flexibility and control during the mix, but on a 1/2-inch tape one of these tracks would be adjacent to SMPTE code and cross talk would be likely. If a 2-inch multi-track were used as a playback source, the mix could be recorded on the same tape. This obviously reduces the number of tracks available as source elements and requires all work to be done in the sel-

sync mode to avoid a delay of the mixed tracks relative to the time code on the tape. Another drawback is the poor cross talk performance of any machine in the sel-sync mode, and the limitation this will place on the mixer in utilization of all channels of the machine.

More confusion and incompatibility are created by the fact that broadcasters and video facilities use 59.94 Hz as the reference frequency for all tape machines to insure correct



The Solid State Logic 6000 Series console at Editel. Note the switch above each I/O module pan pot that routes to either the A, B or C Stereo Bus, for Dialogue, Music and Effects. The left hand center section is the 651 Master Electronics Section. The middle center section starts off with the keyboard, then the video display, then the controls for the SSL Video Switcher, then the SSL Events Controller. The right hand center section holds the mix matrix and 8-track recorder controls, plus space for future SSL developments.



Roughsite after demolition showing main building columns and phone junction box.



Flooring being laid—rubber isolators imbedded in fiberglass with a section of floor laid over it.

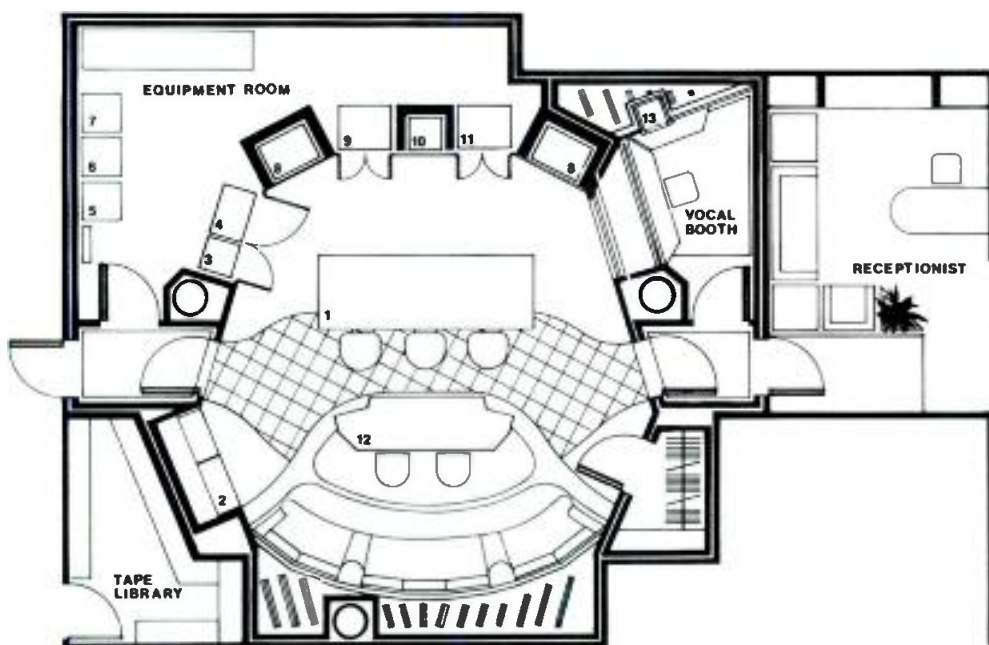

| LEGEND | |
|--------|------------------------|
| 1 | SSL CONSOLE |
| 2 | 1/4 INCH TAPE MACHINES |
| 3 | VCR RACK |
| 4 | 2nd MULTITRACK ⚡ |
| 5 | SSL RACK |
| 6 | 5/16 FILM DUBBER |
| 7 | UTILITY 1/4" |
| 8 | UREI 813 |
| 9 | STUDER 4/8 TRACK |
| 10 | VIDEO MONITOR-30-INCH |
| 11 | STUDER MULTITRACK |
| 12 | OUTBOARD RACK |
| 13 | VIDEO MONITOR |
| ⚡ | FUTURE EXPANSION |

Floor plan of the audio mix room at Editel

play speed. 59.94 Hz is the vertical drive rate used in color television (also called "color sync" because this number is obtained by dividing down from the color sub-carrier), and because it is so close to 60 Hz it is generally used in its place. Recording studios and film facilities usually operate at 60 Hz, either from crystal generators or by relying on the stability of main power, and the potential exists for an error of three seconds over one hour when a recording made at one reference is played back at the other. The use of SMPTE code on audio tape machines tends to reduce the danger of running off speed, but it is important that SMPTE generators be locked to the sync generator feeding all videotape equipment. VTRs lock to their control tracks on playback, and time code must run synchronously with it in order to provide a correct reference to resolvers operating audio machines. Locking SMPTE generators to a common (or "house") sync also allows time code to be regenerated and transferred from any resolved tape machine without the fear of losing sync.

All these perils and possible shortcomings had to be dealt with in the design of the Editel mix room. The room had to

have excellent acoustics without sacrificing style or comfort. Also, tape formats had to be chosen—and in some cases, developed—that had wide application, yielded the required technical performance and were accessible to the average customer.

CHOOSING THE EQUIPMENT

I was fortunate in two important aspects of this project. First, I was building a facility from the ground up, so I didn't face any limitations of room shape, equipment placement or inadequate client seating. Good, solid design would be the main ingredient in producing an ideal working environment. Secondly, the budget allowed the installation of truly state-of-the-art equipment. Exceptional performance and features would combine to create a room capable of the most demanding session.

In March, I flew to the headquarters of Solid State Logic in

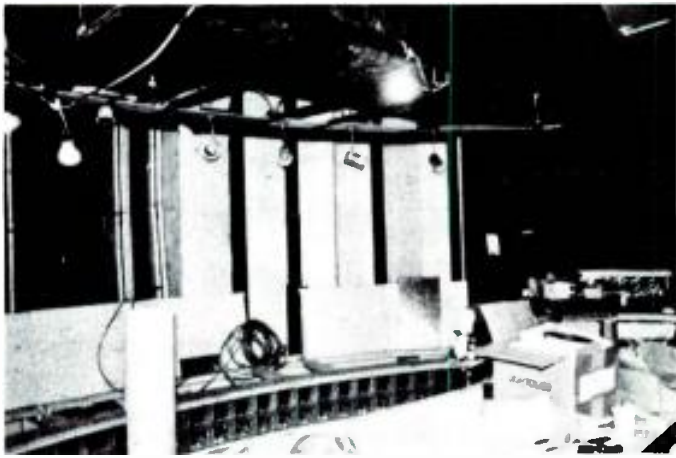

Framing—building column being boxed in.

Stonesfield, England to work out the specifications of a six-bus mixing console. Modifications to the well-established series 4000 console, and the addition of control panels designed specifically for video mixing, produced the first series 6000 E. The six buses allow great flexibility and sophistication in the preparation of tracks for stereo programming of all kinds. The software developed by SSL is also eminently suited to television post-production and will supply a whole level of automation beyond dynamic mixing. One new product is an Events Controller that operates 16 devices, giving a virtually unlimited number of commands to audio cart machines, digital processing devices, cue lights, countdown cues for ADR (Automatic Dialogue Replacement), or non-synchronous tape machines. The board can also store mixing pre-sets and activate them at given SMPTE time codes, allowing scene-by-scene dialogue equalization from



Rear of room showing framing of 15-foot semi-circular couch, sound trap panels suspended in cavity behind.

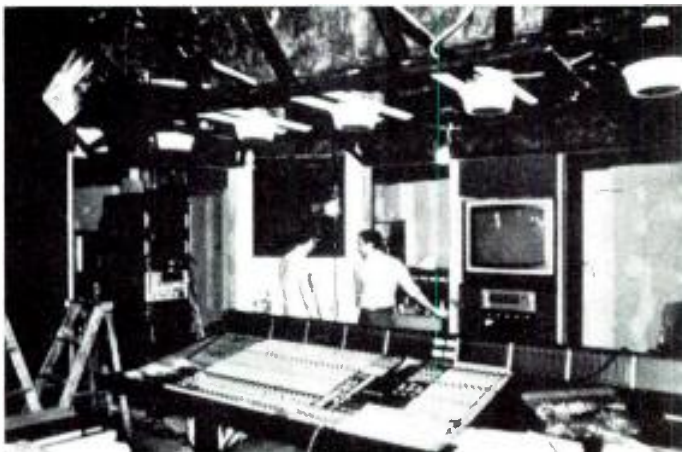

Later stage of construction. UREI 813, 30" Sony monitor, McIntosh 2500 power amp installed in front wall. SSL in place, ceiling framed and waiting for stretched fabric finish.

edit decision lists (which can be prepared off-line prior to the mix) or from cues taken on the fly. All record punch-ins and punch-outs are programmable and are completely gapless, allowing an unusual freedom to mix short sections of program at a time. List management of all automated functions is excellent and allows the engineer to compile useful and pertinent data as needed.

Studer was the choice for tape machines, including an A800 $\frac{1}{8}$ —valuable as a master recorder because of its superb performance and 14-inch reel capacity. The time code channel is another useful feature of the machine, simplifying

signal paths within the room and eliminating any difficulty in using time code on tape. It's such a good feature, in fact, that project engineer Dave Smith designed a code channel mod that he installed on our A80 2-track. ITC stereo cart machines were also chosen because of their performance. Frequency response and azimuth alignment are so good that the players can be used for music cues in addition to sound effect loops. Mag playback (35 mm or 16 mm) is available for those film elements that are so often part of the post-production mix.

All machines in the room are locked to picture at all times using an Audio Kinetics synchronizer system, as specified for the Editel project. The system is distinguished not only by its unusually large capacity, but also by its ability to perform complex tasks—laying out sound effects tracks or performing electronic edits—and then to “disappear” when not

needed. The engineer can concentrate on writing a mix, and the synchronizer will follow commands from the SSL keyboard, chasing and synchronizing whatever machines are in use. Outboard gear is at hand, arranged for convenient operation in cabinetry that doubles as a client tabletop.

DESIGN AND CONSTRUCTION

By far the most difficult and time-consuming part of the Editel project was the design and construction of the room itself. Many unique criteria had to be met: the room had to house a large number of tape machines, sight lines to the video monitor were critical from several locations, a very large console (11 ft. 7 in.) needed accounting for acoustically and ergonomically, and a large number of people had to be accommodated comfortably. Mixing sessions for a commercial can involve seven or eight clients on occasion, more if a last minute screening is arranged before the completed spot is rushed off for duplication or broadcast. At the same time, proper response and stereo imaging must be maintained at the mixing position, and the room has to feel right for music projects as well.

For the structural and interior design I was fortunate to have the collaboration of Editel's staff designer, Ralph Potente, who had recently finished a very dramatic video edit room. His experience with the mechanics of a technical workspace and his all-round ingenuity were invaluable. For

the acoustical design I enlisted the services of Carl Yanchar of Lakeside Associates. I had made an extensive search for an acoustical consultant—someone who had designed exceptional sounding rooms and was capable of rather radical departures from accepted conventions for the shape and appearance of a control room. I visited studios from Los Angeles to Buffalo (I even managed a side trip to the Manor, not far from SSL headquarters in Oxford), looking and listening for the right combination. I became convinced that Carl's meticulous detailing was just what was needed in such an elaborate project.

Early in the design stage we received a major setback when it was determined that the chosen site had insufficient load-bearing capability. To increase ceiling height in the shooting stage below, the floor of the area we were dealing with had at one time been raised up with a resulting load limit of 50 lbs. per square foot—exactly the weight of a 4-foot concrete slab. Since isolation from the sound stage was critical, and the cost of strengthening the floor would be prohibitive, a new site had to be found. Examination of the building's plans revealed an ideal location on another floor, but the spot was occupied by about a dozen offices. Arrangements had to be made to re-locate staff, demolish the site and redesign the mix room.

Site preparation involved the removal of several cement block walls, an extensive air conditioning and sprinkler system and the removal and re-wiring of the main junction box for perhaps 100 phones on the floor. All of this, and the

subsequent construction, was carried on one door away from Editel's videotape duping facilities which had to be carefully protected from dust.

Isolation requirements dictated that the floor and ceiling for the room be floated, and because of the difficulty of dealing with wet cement in an active working environment, an alternative system using pre-cast concrete planks over steel and rubber rails was developed. We decided however on an even more attractive system of layers of material (plywood, sound board and sheetrock) sitting on isolating blocks. Materials were easy to work with and no cutting of concrete was necessary. Because we felt that the existing tie rods wouldn't be sufficient to bear the weight of a hefty ceiling, an alternative suspension system was worked out on-site by chief carpenter Rocco Corrizzo. Plaster was chipped away from the main beams and angle iron was welded in place. Threaded rods were then run through holes drilled in the angle to rubber isolators above, and bolted to plywood below that acted as the first layer of the ceiling.

Double stud construction was used in all walls and the extensive detailing created by the complex shape of the room presented daily challenges for the carpentry crew. For instance, the plans called for a separation between the mix room and the vocal booth, extending through the floor, wall and ceiling. This separation is approximately 1/4-inch, and great precision was required in maintaining it. After the monitor wall was constructed, we made measurements to check our accuracy in plotting the exact positioning of the

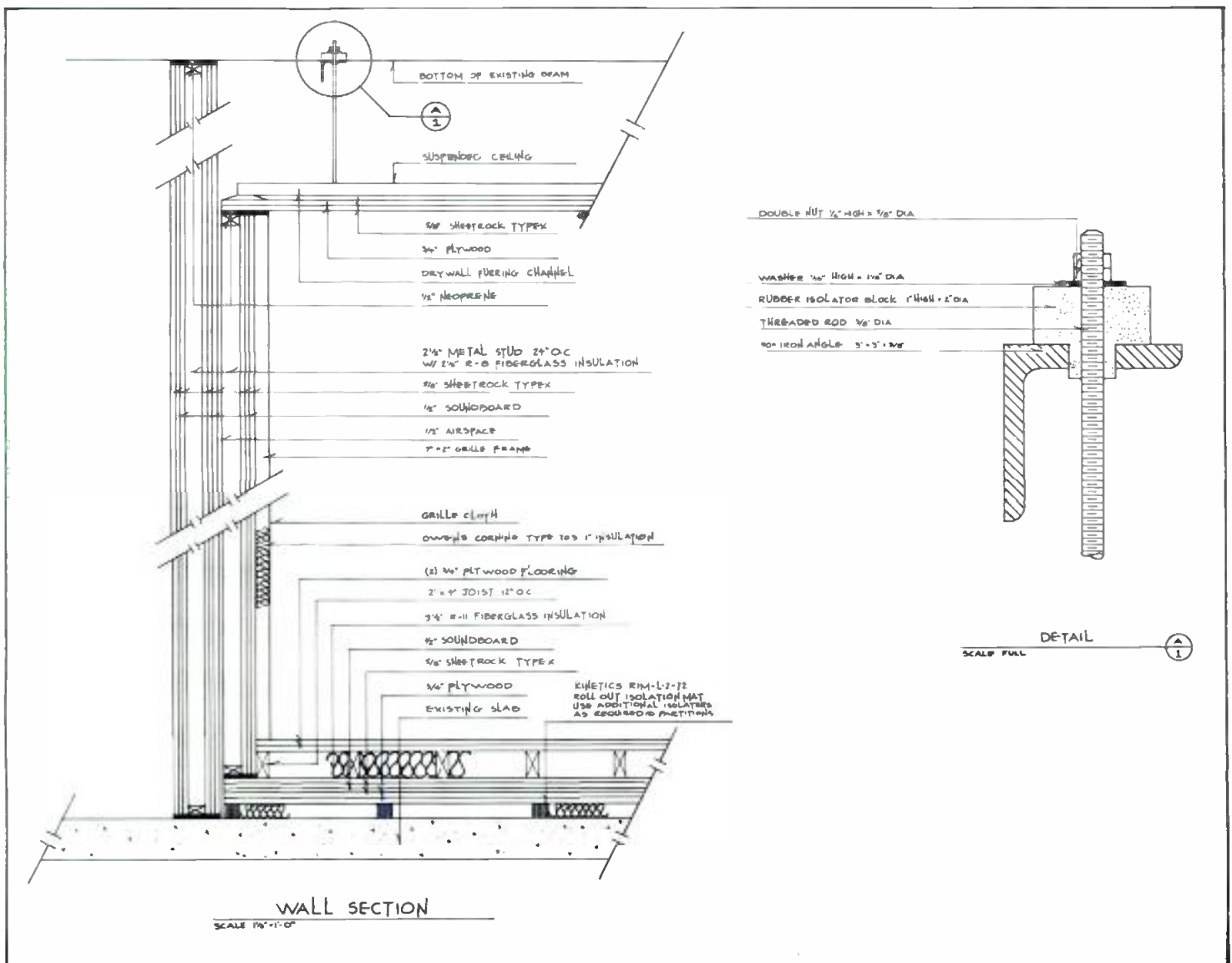

db March 1983

Wall section, along with detail, of the audio mix room

monitor soffits. We found that the center of the stereo image was within 1/2-inch of the actual center of the room. Building any sound facility is extremely demanding, and the skill and intelligence of the crew for the Editel project was key to its success.

Machinist Eddie Pohlduka was also put to the test by this project. Most of the front of the room consists of glass doors, and Ralph designed an attractive combination of tinted and wire glass. When no commercially available frame could be located, he designed the framing as well. Because of the large size of the door and the need for good acoustical seals, the machining of the frames was an exacting job. Equally difficult was devising and constructing a rail and sliding arm system that carries the synchronizer controller from one end of the 11-foot console to the other. It is both an attractive and useful device.

Cable troughs were designed to be accessible at all times. Therefore, all cable harnesses were made up and wired to connectors off-site long before construction was completed. This avoided considerable delay and the danger of dust getting in the connectors.

No major delays were encountered in acquiring equipment—the Studers were on hand quite early (even the Prototype 4-track A800) and the SSL arrived within days of scheduled delivery. Work had been proceeding for several months on the design and fabrication of various ancillary control systems. Dave and I designed a control pulse matrix that serves as the interface between the SSL events controller and nearly every piece of equipment in the room. The matrix provides flexibility in routing transport commands, record pulses, and external triggers to tape machines including remote VTRs, cart machines, cue lights, and digital effects processors.

The philosophy behind this extensive interfacing was maximum utilization of all systems without drowning in key-strokes. For example, the mixer can opt to monitor the repro head of the master recorder during mixing. This acts as a nice form of quality control and eliminates the danger of cross talk encountered in the sel-sync mode. Offsets are programmed into the computer to keep picture in sync with the delayed audio from the repro head. If program source needs to be checked against picture, a DDL set to the same value as the programmed offset can be switched into the VCR time code output. Because the bandwidth of the DDL is limited, a logic circuit bypasses the DDL when the VCR is in a wind mode. This may sound very complex, but the mixer only has to press one switch (DDL in) to activate this process.

IN CONCLUSION

My concept for the Editel mix room had been a true state-of-the-art facility that was capable of any project—commercial, documentary, record album—without compromising quality, flexibility or efficiency. Achieving this goal depended to a great extent on the existence of the equipment needed—SSL, Studer, Audio Kinetics—and the cooperation of these manufacturers in meeting the needs of the user. It also depended on the coordination of the efforts of many talented experts from different fields. All elements of the room are cohesive; function is never sacrificed for appearance and vice versa. Ralph's design for the interior is both stunning and logical. Equipment is not hidden, but is the central feature of the room; interior shapes and patterns are drawn from the styling of the machines. Entry doors are massive and beautiful; floor tiles allow easy movement of heavy equipment and create a striking visual element. Similarly, the acoustical performance of the room perfectly accommodates the requirements of all participants in a session. The sound is excellent and uncolored everywhere in the room, but more intense at the mixing position. While the sound is gentler in the rear section, people seated there are very much part of the action, but with a bit more privacy.

A project of this scale called for unique mechanics and they produced a unique room—a complete video sound mixing facility.

CAREERS IN AUDIO ARTS

"I MIX SOUND MAGIC"



NEW, HANDS-ON PROFESSIONAL CAREER PROGRAM

24 Track Studio Console
State-of-The Art Equipment
Multi-Track Editing & Mixing
Audio for Film & TV
Individual Work Stations
Music Recording Sessions
Digital Technology
Audio & Recording Arts Division
Classes Forming Now!
(212) 807-6670
Grants and Loans
Available for Eligible Students
Use this coupon or call

Please send me your Careers Manual and Catalog of courses in Audio and Recording Arts.

Name _____

Address _____ Tel. _____

City/State/Zip _____

226 WEST 26 ST. NYC 10001 (212) 807-6670

Circle 36 on Reader Service Card

MAP AUDIO FOR NEW or RETRO FIT REQUIREMENTS



3350 EQUALIZER

- 3 Ranges, 12 Frequencies
- Shelving or Peaking
- Transformer Output
- Selectable Band Pass
- And More

- 5 1/4" x 1 1/2" mtg space
- ±15 Volt Supply



3320 COMPRESSOR/LIMITER

- Attack Time 10 micro Sec
- LED Visual Indication For Gain Reduction
- Variable Threshold, down to - 50 dBm
- And More

And ask about our IMPAC Frame Modules



Visit our booth 325 at NAB

Circle 34 on Reader Service Card

Tips on Recording From the Telephone

Reach out and interview someone.

FOR NEWS AND information programming, audio recorded via the telephone is a staple. To hit the air fast—even in these days of satellite transmission, fiber optics and digital technology—the telephone remains the most common conduit for on-location sound. Yet as studio and distribution quality improves modern broadcast audio, telephone audio becomes even more of an “earsore.” Nevertheless, we must resign ourselves to the fact that, in many cases, a phone-feed is the *only* route when we need to air something newsworthy from a remote location in a timely manner, and will probably remain so for some time to come.

PROGRAMMATIC CONCERNS

Of course, the first approach is to reduce the use of “phoners” to a bare minimum. Don’t use a phone feed for anything other than a breaking story. Feature pieces or other non-date productions should never use phone-quality audio. (Even for distant interviews, there are ways to avoid the use of phoners entirely, and these are explained below.)

If a phone feed *must* be used, keep it as short as possible. Rewrite whatever is appropriate into announcer copy, leaving only the pure actuality or live sound from the location via phone. If a reporter is filing a story from the field, the report should be as concise as possible, leaving all background information to the anchor or studio announcer. Highly-produced documentaries and the like should not use phoners at all.

INTERFACING

When phone audio is recorded, it is imperative that the proper equipment be used. Recording *from* the phone is somewhat more difficult than feeding *into* the phone from the field.

One simple interfacing device is the VOICE COUPLER, known in telephone company parlance as the “QKT.” This small box is permanently wired into a phone instrument or line, and provides a quarter-inch phone jack output for feeding a line level signal to a console or recorder input. When using a coupler, it is most convenient to have the telephone instrument on-line with it equipped with a push-to-talk switch on its receiver. This is because the instrument’s receiver has to be off-the-hook while a feed is coming in, and the push-to-talk switch turns off the receiver’s mouthpiece microphone when it is not depressed, thus insuring that noise and conversation from the studio side will not be included in the recording. (The coupler also allows feeding a line level signal *into* the phone line as well, in lieu of clipping on to the receiver.)

For professional-quality phone feeds or two-way phone recordings (the phone interview) or broadcasts, a much more complex arrangement is required, usually involving a variation on the “speaker phone” or “telephone hybrid.” A detailed article on the subject can be found in the *NPR Engineering Update* (Vol. 2, No. 9 [April 1982]).

Other methods of recording from the telephone such as suction-cup transducers and the like are generally unacceptable for broadcast of either one-way feeds or two-way conversations.

IMPROVING PHONE AUDIO QUALITY

Once the phone has been properly interfaced with a line level input on a console or similar device, some amount of

audio processing is usually in order. This can be done as the phone feed is being recorded, or the feed can be recorded flat and then processed during subsequent production or dubbing. The audio processing that is useful for phoners can be divided into three areas: filtering, equalization and compression.

Filtering The first step, filtering, should employ a device with a very steep shelving-type high-frequency roll-off (a low-pass filter). This should be set to roll off at three to four kHz (but adjusted by *ear* to each phone feed). On a standard phone line there is little or no audio above this frequency, but there is noise. Generally, the longer the distance of the call, the more noise there will be on the line, and so the filter's roll-off point should be adjusted relative to the amount of noise. Of course, the trade-off to removing noise is some loss of high-frequency audio (i.e., intelligibility), so not all the noise can be filtered out. Your ear will determine the exact adjustment for the filter, balancing the amount of noise removed against the amount of intelligibility lost. It is better to err on the side of caution here: a little noise left in is preferable to a quiet but dull phone voice, which is more difficult to understand.

On some phone calls, or with some phone interfacing devices, low-frequency hum is a problem. This can generally be removed without further degradation of audio by the use of a shelving-type low-frequency roll-off (high-pass filter), set to around 150 Hz. So-called notch-filters can also be used to remove this hum or any other discrete tones often found on phone lines. A good device of this kind is the UREI 565 "Little Dipper" Filter set.

Equalization The next step is equalizing the phone line to increase intelligibility. Using an equalizer to reshape the frequency response of the phone line within its audio bandwidth can result in marked improvements in intelligibility. The equalizer should be patched in to the audio chain following the filter(s). (Many processing devices offer high-pass and low-pass filters *plus* equalization in a single, multi-stage unit.)

Although the equalizer's settings will be different for

every phone line, the following basic curve is usually helpful, with the sections of the curve listed in decreasing order of importance:

1. 6 dB CUT at 400 Hz, wide bandwidth.
2. 3 dB BOOST at 2.5 kHz, narrow bandwidth.
3. 3 dB BOOST at 200 Hz, narrow bandwidth.
4. 2 dB CUT at 800 Hz, moderate bandwidth.

Basically, what this equalization curve does is decrease the energy in the middle of the phone line's bandwidth and increase the energy on both ends in an attempt to flatten out the response. The typical phone line's excess of energy in the 400 Hz region has a particularly negative effect on intelligibility. Reducing energy in the 400 Hz region alone will improve almost any phone line's sound.

Compression Because of the reduction in energy caused by equalization, the phone line's intelligibility is improved, but its overall volume and "loudness" is reduced. For this reason, a moderate amount of compression after equalization is recommended. This will restore or even enhance the loudness of the phone line, which further improves its listenability beyond the intelligibility increase afforded by equalization. Compression can also serve as a protection device by helping to catch any excessive audio peaks that the phone-line signal may have. More importantly, when the phone audio is to be mixed with other full-fidelity audio (such as a phone interview where the interviewer is in the studio and the guest is on the phone), compression of just the *phone* audio can help increase its loudness relative to the studio voice. Without such compression, proper loudness-matching of the elements to ear will result in widely divergent VU meter readings between the studio and phone audio. (Typically, an uncompressed phoner hitting 0 VU will sound loudness-matched to a close-mic'ed studio voice reading around -10 VU.) This can result in difficulties when matching that recording to other studio-voice-only recordings in the same program in which the studio voice is generally recorded at a much higher VU level. It is also an inefficient use of the dynamic range available on the tape, resulting in an overall

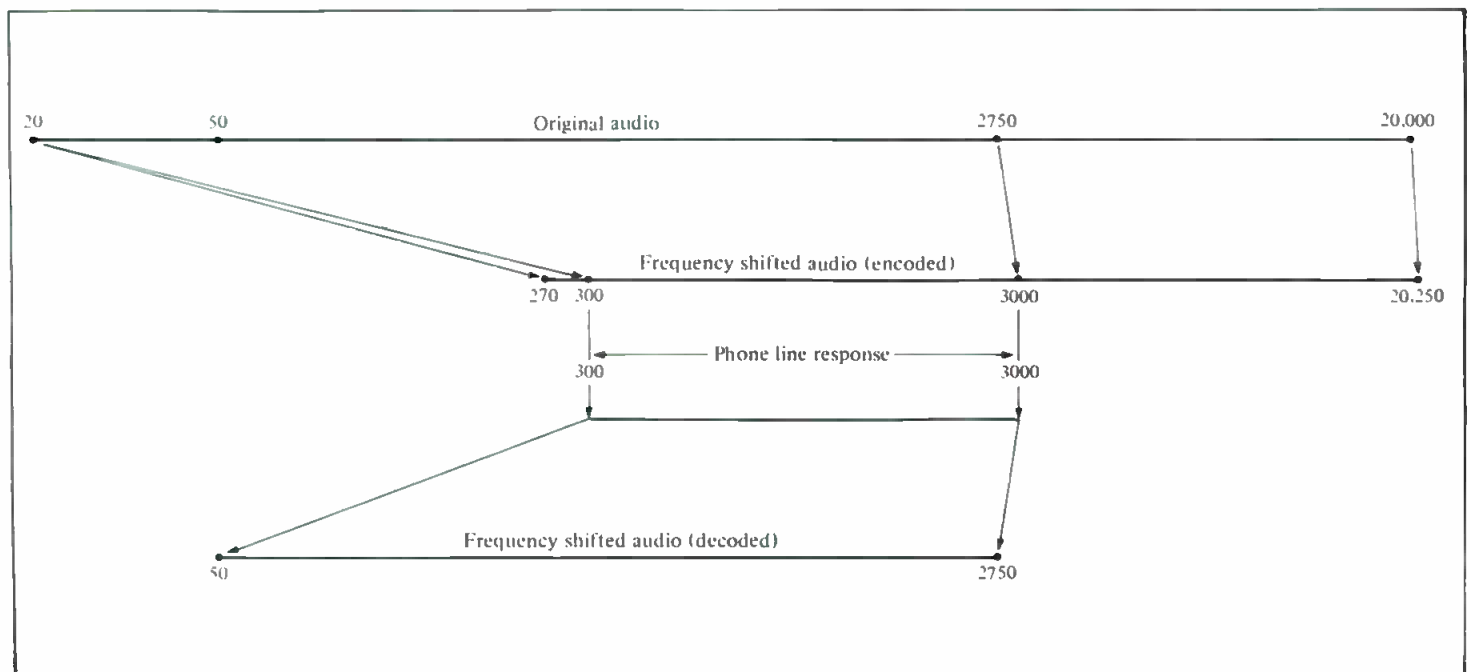

Figure 1. By using a frequency shifter, a typical phone line response may be improved to 50 to 2,750 Hz.

noisier recording.

The other side of the compression coin is that while the phone audio's apparent loudness is increased, so too is any background noise on the phone line. In many cases, this noise level is rather high to begin with, and compression just makes it worse. Therefore, as with any audio processing tool, use it with moderation.

DYNAMIC NOISE FILTERING

Another effective processing device for phone audio improvement is the Dynamic Noise Filter or "DNF," manufactured by KLH/Burwen, Audio and Design Recording, and others. This device serves to filter out noise

because they are designed to be used with tape systems to reduce tape hiss, and are expecting to deal with a reasonably wide bandwidth and fairly flat record/playback frequency response. They are also expecting to encounter simple tape hiss between encoding and decoding, and not all the other nasty noises and general audio havoc that phone lines can generate so prolifically.

The best application of these devices is on permanently or temporarily installed, or dedicated phone circuits, *not* on your basic dial-up beeper. In this way, lines can be filtered, equalized, and level-matched (the Dolby systems require particular attention to the latter) to provide noise-reduction

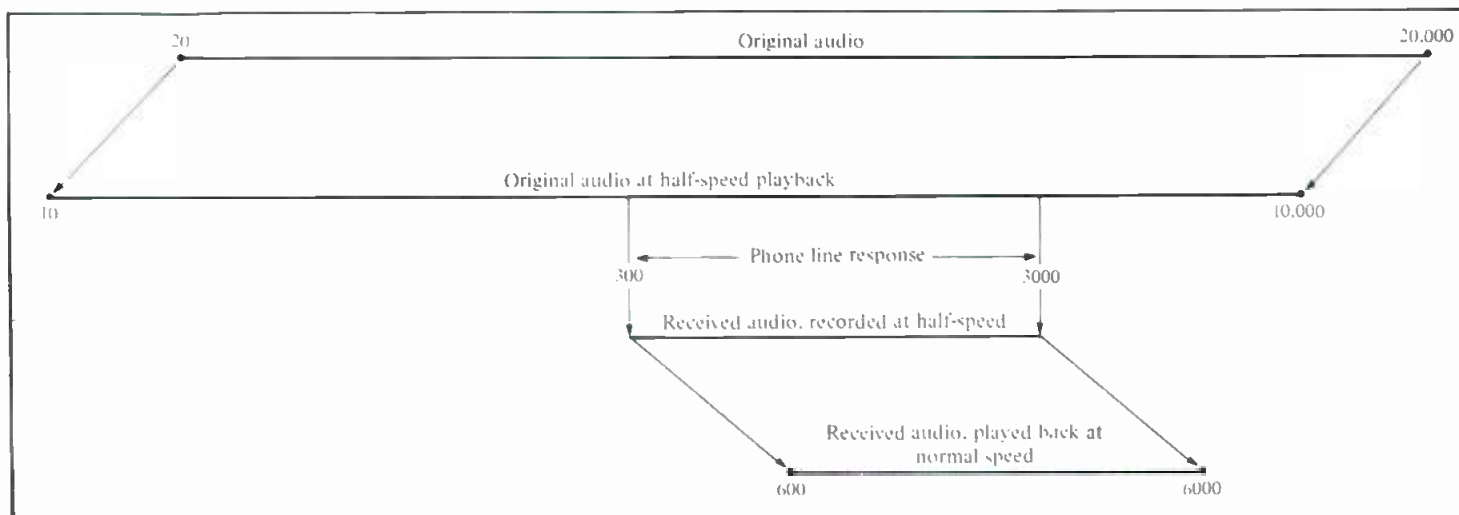

Figure 2. When the phone line is used to transmit a half-speed recording, the restored (normal-speed playback) will have a 600 Hz to 6 kHz response.

"between the words" of the voice on the phone, and can often clean up a noisy line without much of a negative effect on the desired audio. Some DNF units are very easy to operate, while other, more flexible designs are quite complex. Some are designed specifically for telephone audio. Beware of using a DNF on digitally-processed phoners (such as the ITT/ROLM system and others), or other extremely noisy, satellite-fed long-distance lines. In these cases, the gating (opening and closing around the words) effect of the DNF may make the noise more distracting by its coming and going with the words than if it were just there at a constant level all the time. In many standard phoner situations, however, a good, simple DNF can be a very useful and expedient tool for improving phone audio.

MORE EXOTIC APPROACHES

In recent years, a few more unusual "back-door" approaches to improving phone line quality have been developed. Because the basic dial-up phone line exists with limited bandwidth and limited signal-to-noise, any way of squeezing in more bandwidth or S/N would be welcome, even at some expense, since over the long term, purchasing better quality phone lines might be prohibitive. The only way to get "something from nothing" here, that is, to effectively extend frequency response and S/N beyond what exists on the phone line, is to use some sort of encode/decode process. This artificially affects the audio just before it enters the phone line, and reverses the effect at the other end of the line where the audio is received. This is similar to the complementary noise-reduction process used by Dolby, dbx, and other systems where the limitations of the intermediate storage (or in this case, transmission) medium are overcome.

SIGNAL-TO-NOISE EXTENSIONS

One of the above-mentioned systems may be used to help reduce phone line noise, but with caution. While noise may be reduced, audible effects (pumping, breathing, noise-modulation) may be introduced, which may be more obnoxious to the listener than the noise itself. The reason these devices (Dolby, dbx, Telcom, High-Com and others) don't always work well on standard dial-up phone lines is

with a minimum of audibly annoying side-effects. Of course, this can take a considerable amount of time, so it should not be undertaken on a lark. But if a noisy phone line situation comes up, and you happen to have a noise-reduction system handy, with one unit for encoding that can go into the field on the transmit end of the line and stay there for the duration, plus a decoder at the station, some equalization and filtering equipment, and a little spare time, try it. You may be quite pleased with the improvement. A potential problem with this system (on narrow-bandwidth circuits), even after the line is flattened out, is mistracking of the decoder, because it sees considerably less of the audio spectrum than the encoder saw at the transmit end. Consequently, the decoder cannot properly undo what the encoder has done, since the audio was band-limited after it was encoded. The solution: filter the audio at the transmit end, *ahead* of the encoder, with the cutoff frequencies equivalent to the bandpass of the telephone line. Steep slopes are preferred. Even after this, long-haul circuits may still exhibit some mistracking due to frequency-response anomalies. Each section of the circuit must be made as flat as possible within its bandpass for optimal results. Local circuits, especially the 15 kHz variety, are the easiest to use noise reduction on, since they should be reasonably flat, and the 15k lines don't usually require the "pre-filtering" described above. To reduce potential problems further, the non-level-critical systems are recommended (dbx and Telefunken products), since then only frequency response (and not *gain*) need remain constant through the circuit. On 15 kHz lines, remember to check response *above* 15k. Telco guarantees flat response to that point, but don't assume that the circuit's response *rolls off* beyond 15k: it may do just the opposite, which could cause real problems when noise reduction—especially of the pre-/de-emphasis variety (dbx)—is added. (One caveat: The system described above is for use with *one-way* phone line feeds *from* the field. Two-way recordings incorporating noise reduction require a separate non-noise-reduced "backfeed" for sending the studio audio to the remote site, meaning *two* phones are required at the remote site. The backfeed can be a simple dial-up.)

FREQUENCY SHIFTING

On the other hand, a more sure-fire approach to improving phone line quality involves squeezing more *frequencies* into the line than it will normally pass. Or, more accurately, passing *different* frequencies through it than what it can usually pass. Devices marketed by Comrex, McCurdy and others will, by an encode/decode process, substantially increase low-frequency response of phone lines, at the expense of a very slight loss of high-frequency response.

The Comrex unit, for example, shifts all audio frequencies *up* by 250 Hz in the encode mode (going into the phone line) and *down* 250 Hz in the decode mode (coming out of the phone line). The net result is a gain of 250 Hz on the low end of the phone line's response and a loss of 250 Hz on the high end. This means a typical phone line's response of 300 to 3000 Hz will, with Comrex encoding and decoding, pass 50 to 2750 Hz (see FIGURE 1). This *linear* frequency shift means proportionately more to frequency response on the low end of the phone line's response than it does on the high end.

One other note regarding frequency shifting: Decoding must be done in real time. That is, the frequency-shifted phone audio must be decoded as it comes out of the phone, before it goes onto tape. If the frequency-shifted audio is recorded without first decoding, with the idea of later playing the tape back through the decoder, all sorts of interesting but unairable results may occur. These due to the *additional* slight frequency shifts introduced by the recorder; the decoder is not expecting to see these, and is quite intolerant of them.

HALF-SPEED TRANSMISSION

Subjectively, though, adding *low* end to a phone line does not always help; in fact, it may be the *last* thing you need as far as improving intelligibility goes. To solve this problem, another encode/decode process can be implemented, this one adding *high*-frequency response, and doing it in an octave-doubling, or *multiplicative* way regarding frequency, as opposed to the linear or *additive* method used by the frequency shifters. This technique very simply employs half-speed transmission.

In this case, all frequencies are divided by two by playing back a recording at half-speed. Every reel-to-reel tape recorder, and some cassette recorders, have at least two speeds available. To use this process, record the material at the higher tape speed, then phone-feed it with a half-speed playback. At the other end of the phone line, the phone feed is recorded at half-speed, and then played back for airing at normal speed. What goes through the phone line is, of course, nearly unintelligible, since it is half-speed audio. The phone-feed also takes twice as long, which may be a consideration on long distance, dial-up calls. After the half-speed phone-feed is recorded, it is rewound and played back at normal-speed. It should now be intelligible and have a nice *high* frequency response, but will probably sound extremely thin and lacking in *low*-end. For this reason, this technique is generally not used for broadcast purposes (see FIGURE 2). But, when half-speed transmission is used together with the frequency-shifting process mentioned earlier, then phone-feeding results really begin to improve. The high-frequency improvements of half-speed transmission combined with the low-frequency improvements of frequency-shifting make for a quite extended effective response, and the frequency losses inherent to each process are more than cancelled out (see FIGURE 3).

Some other notes regarding this kind of transmission: It is hard to evaluate the effect of the phone line or interfacing equipment on the audio in terms of noise or distortion when listening to half-speed/frequency-shifted audio at the receive end. For this reason, it's best to first audition the phone line's quality with audio sent at normal speed. Once levels are set, and tolerable amounts of noise and distortion are achieved, then half-speed transmission may begin. Additionally, since

the noise spectrum on a phone line is generally not flat, the quality of the noise will change when playing back the phoner recording at double-speed. It may therefore be necessary to filter some noise when playing back for air, or to dub the phoner recording through a filter before airing. This filtering *cannot* be done while recording the phoner, since that process is taking place at half the eventual playback speed, and both the audio and line-noise distribution are an octave lower than that at which they will eventually be heard. Finally, it should be mentioned that there are equalization anomalies introduced by the recorder when recording at one speed and playing back at another. But since we are dealing here with much more severe frequency response anomalies due to phone-line transmission, these can essentially be ignored.

In summary, it can be shown that half-speed transmission alone is rarely useful; frequency shifting alone can occasionally be helpful; and both together are quite useful in improving the effective bandwidth of a phone line. Of course, for live transmissions from the remote location, half-speed

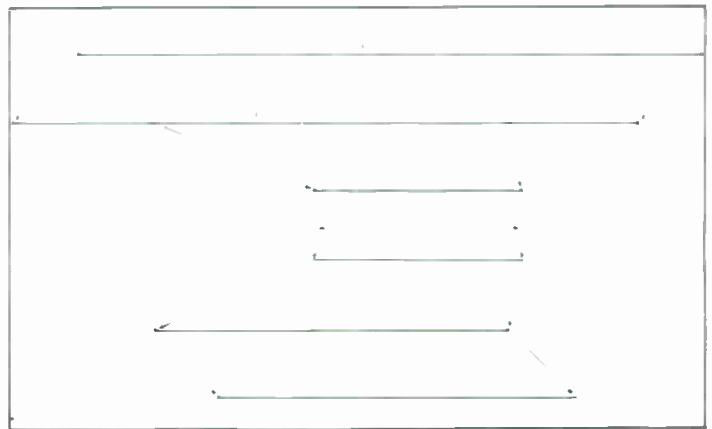

Figure 3. A combined half-speed, frequency-shifted transmission offers a playback response of 100 Hz to 5.5 kHz.

cannot be used. In such cases, frequency shifting alone may be worthwhile. On the other hand, if frequency shifting equipment is available, and an already-recorded piece must be phone-fed for later airing, it takes no additional equipment to use the half-speed, frequency-shifted transmission technique. (It does require more time, however, both on the phone and in the studio.)

ADDITIONAL ENHANCEMENT

Some people have experimented with phoners played back through so-called "aural exciters," with some favorable results. These devices are proprietary-designed processors intended to enhance the "realism" or "richness" of high-fidelity recordings. However, they also seem capable of improving intelligibility and listenability on phoners, without a tradeoff in excessive noise increase. These devices are manufactured by Aphex, EXR and others, and are somewhat expensive (but are generally available on a rental basis). They must be used with moderation, and will not always help. But, they can often help put the "edge" back into otherwise dull-sounding phone audio.

THE PHONE-SYNC

The "phone-sync" technique can eliminate the phone entirely from an interview done over the phone. It requires more production time, and is therefore generally inappropriate for breaking news stories, but can be quite helpful in feature-type stories or other highly-produced pieces where phone-quality audio is especially inappropriate.

The process requires a two-track tape machine at the

studio end, and a good recorder at the remote end. At the studio, a typical phone-interview is done, but with a twist: the studio voice is assigned only to the left track of the tape, and the phoner output is assigned only to the right track of the tape. (It is helpful if the interviewer in the studio can hear a mono sum in his/her headphones.)

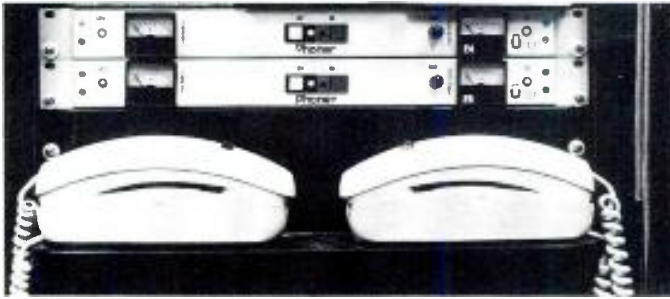

Figure 4. National Public Radio's in-house built phoner units.

Meanwhile, on the remote end, the guest merely conducts a normal phone conversation with the interviewer, speaking into and listening from the telephone receiver. However, someone is simultaneously making an on-location recording of the guest's conversation only. No interfacing with the telephone is required at that end. In fact, it is important to make sure that none of the phone audio can leak into the microphone from the receiver earpiece. Therefore, the recording mike should be placed on the opposite side of the talker's mouth from the telephone receiver, and the guest should be instructed to hold the phone tightly to his/her ear and not move around a lot.

Once the interview is completed, the recording made at the remote location is sent to the studio. When it arrives, this recording is placed on one tape machine, and cued to the beginning of the interview. The two-track studio recording is cued to the same point, which is found by listening to the right (phoner) track. Then both machines are started at the same time, their outputs mixed, and a new combined recording is made on a third recorder. Only the *left* (studio-mic) track of the studio recording is used in this mix. The right track is used purely as a reference, since it is the only common element (or "sync-track") between the two tapes. This track should be occasionally listened to in "cue" to see how far apart the two tapes are drifting (which they will always do). If the two tapes drift sufficiently apart to affect



Figure 5. An Orban 672A "Paragraphic" equalizer, with typical "phoner-fix" settings shown. The settings are approximately 55 Hz/0 dB, 120 Hz/0 dB, 150 Hz/+5 dB, 400 Hz/-7 dB, 600 Hz/-4 dB, 2.5 kHz/+4 dB, 4.5 kHz/0 dB, 5 kHz/-1 dB. The high- and low-pass filters on this unit are not as steep as on the UREI "Little Dipper," which is used for this purpose and is inserted ahead of the Orban equalizer. The dbx 160 compressor gives good results with phoners. (Photos by Skip Pizzi.)

the dynamics of the conversation, all recorders should be stopped, fader levels left untouched, the two playback machines rewound a few seconds back, re-synced, and the recording restarted. A pick-up edit in the new mix recording is made later. Any audible leakage on either end will make sync-drift instantly apparent, whereas without leakage, a full half-second or so of drift is often tolerable before re-syncing is required. If you're careful, and there is not a lot of background noise on either tape, sync-correction can be done "on-the-fly," by stopping the machine that is leading for the amount of time that the lead appears to have accrued, and then restarting it (while the person on the lagging machine is speaking, of course). Quick fades up and down around the stop usually help. By the way, varispeed during the syncing process is generally not recommended, since it generally creates more error than it fixes, except when a gross speed error exists on either the studio or (more likely) the remote-end recording.

Once the synced recording has been made, editing can take place on the new, mixed recording. A generation is lost, as is a lot of time, but if the latter can be tolerated, the former is certainly outweighed by the total elimination of the telephone from the new recording. The limiting factor is usually the quality of the recording equipment at the remote end.

Additionally, audio processing can be added to either side of the conversation independently in an attempt to match acoustics or whatever. Differences in microphones can be readily apparent to the listener in such a situation, so every effort should be made to put the remote guest in a quiet, dead environment, and to use identical, or at least similar, mic's on both ends. (The remote end of the phone call can be another radio station—if the guest is willing to travel to a nearby facility and studio time is available. Or, a remote recordist can go to the guest.)

Should the remote tape be lost in transit, or not arrive in time, the studio two-track recording can be mixed-down or summed, with optional audio processing on just the phone track, and a regular phone-interview recording is the result: nothing lost—nothing gained.

OTHER GENERAL TIPS

Remember that in most cases, you need not be satisfied with the quality of the phone line on the first attempt. Redial the call if the first connection is very noisy, distorted or low level. If the call is long distance, call the operator and say, "This is station XYZ, and we have been unable to get a broadcast quality line to _____ (phone number). Can you please help us get one..." etc. Occasionally, the words "PRESS" and "URGENT" can have some effect, especially when dealing with overseas operators. Of course, if IDDD (International Direct Distance Dialing) is not available to the desired location (such as many Eastern-bloc or third-world countries), and a call must be ordered for later delivery, you take what you get, unless you can wait another six hours or whatever for another (usually worse) line.

When someone is speaking into a regular telephone receiver on a phone-feed or interview (especially from an outdoor pay-phone), and the sound is muddy and/or distorted, ask the person to rap the receiver mouthpiece sharply against a hard surface a few times. This serves to break up any coagulations of carbon granules in the microphone that ambient humidity may have caused (much like the salt-shaker in the summertime). Often the sound will be greatly improved after this technique has been applied.

Finally, consider the situation when a reporter is filing a *voicer* from the field, but has a portable recorder, clipleads, and microphone along. If time permits, the voicer should be filed through the portable recorder and mike, clipped onto the receiver, rather than by just using the telephone's microphone, even though no tape cuts are to be filed. The quality improvement will generally be well worth the extra time and effort. ■

The MCI JH-800 Console: A Survival Report



FRANKLY. THE INVITATION to review the new MCI JH-800 wasn't entirely welcome. My academic load had really piled up: committee work was especially bad this semester; my course load had climbed to six classes; the paperwork on my Music Engineering interns had gotten fouled up, as had all my paperwork. And the recording schedule was picking up—we had almost a dozen concerts in the next week—not to mention the Miami Opera performances at the end of the week. Of course, they needed the review yesterday. I could have turned it down, but I didn't. (I needed the money.)

I leaned back in the chair and put my feet up. I reflected—they want a test report? I would give them one. A test report to end all test reports, not another of those wimpy test-bench things that always say how good the device is and the tester pockets his fee, thank you very much. I would give it a real test. I remembered how I used to evaluate amplifiers—square waves at 100 kHz, then throw them off the back of a truck, and test again. It was that kind of meanness that I had

in mind for the MCI. I thought about that luggage commercial where the gorilla throws the suitcase around—that kind of test report. Ah yes, the old gorilla test—that reminded me of my students. I leaned back further and reflected on their philosophy which states that the best off-road vehicle is a rented car. I thought of the crushed windshields, the dismembered cables—my student gorillas are almost as tough on equipment as professional engineers. I smiled, and picked up the recording schedule; they would be eager to try a new console. I checked off three concerts. Our hot jazz band would make that board munchy, our long-hair symphony would make it crunchy, and the new wave group would make it intermittent. They want a test report? I'll give them a test report. They'll be sorry they asked. I'll carry that console back to Fort Lauderdale in a Hefty bag.

A phone call interrupted my reverie; a big carton had just arrived. I went downstairs. It was from MCI—a small box. Could it really contain a twelve-input board, with four sends and returns, communications, and automation-ready? It didn't make any difference—it was going to be the end of the road for this console. I looked down at the box disdainfully and gave it a kick with my motorcycle boot, and it hurt my toes—the carton was undented. I hated it even more. I flagged down two students and asked them to carry it

Ken Pohlmann is the assistant director of the Music Engineering Program at the University of Miami and is a regular db columnist.

upstairs...carelessly.

TO BUSINESS...

I opened the box and pulled out the yellow manual, the preliminary documentation for the JH-800. It's a portable in-line modular console with up to twelve microphone and line level inputs, two stereo mix outputs, four send outputs and



The JH-800 Compact Console power supply

returns, and headphone/microphone communications and foldback system. The power supply is housed separately and provides all operating voltages plus phantom power. It connects to the console via a 2½ meter cable with Tuchel connectors on each end. A detachable meter turret contains seven dual-channel fluorescent bargraph meters. Peak and VU modes are available. The meter turret mates directly to the console with a multi-pin connector; it is secured with three thumb screws.

The input modules have separate level controls for input and output, and pan controls. Channel faders control VCAs with the provision for assignment to any of four group faders. Each input module has three-band equalization and high- and low-cut filters. The three returns are grouped as one stereo and two monaural returns; the monaural returns have separate level and pan pots, the stereo return has level and stereo balance. A communications module provides a two-

way communications system plus foldback through the sends. Also, an oscillator with warble, noise and slate is placed on the module. The monitor module routes and controls output level of speakers and headphones. There are also monitor mute and mono buttons. Two master modules contain two stereo mix buses and four sends. The stereo master faders control VCA output levels. Each master module provides a stereo compressor and limiter; the limiters have a level control and the compressors have variable compression threshold, compression ratio, attack and release time. The four sub-group faders are placed on the return, monitor and two master modules.

The bells and whistles looked okay on paper, but what can you tell from ad copy? I pulled the console from its box and set it on my desk, pushing my paperwork aside. (At least it's good for something.) Even without the power supply, it is a heavy console—definitely a two-man job. I looked it over—an

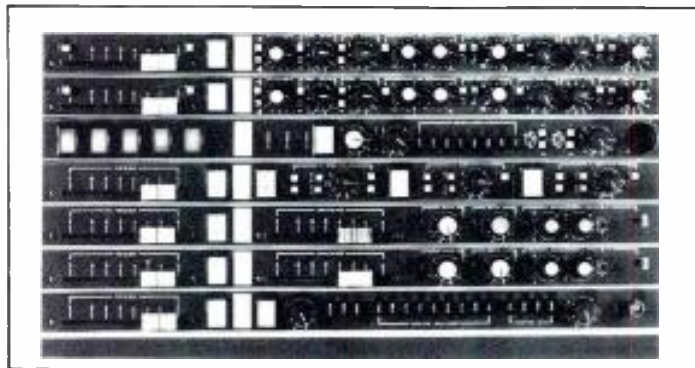

The JH-800 Compact Console rear panel connections

STL

PRECISION



MAGNETIC TEST TAPES

STANDARD TAPE LABORATORY, INC.

26120 EDEN LANDING ROAD #5, HAYWARD, CALIFORNIA 94545 • (415) 786-3546

aluminum mainframe with wood sides, very compact, and well laid out. Unlike some other boards I've seen, I could actually get my fingers between the knobs. I tried the faders—smooth as silk—the best faders I ever felt. No, I reminded myself that I wasn't going to show pity. I mated the meter turret and eyed the fluorescent meters—four stereo bars for mix A, mix B, and compressor A and B, also four bars for the four sends, and two for stereo monitor. Selection buttons switch between peak and VU for the mix, send, and monitor meters. The compression meters show compression in decibels. Three broadcast switches provide for off-air mode, ready mode, and on-air mode. A PFL speaker is built in. It all seemed solid enough, but I was just beginning to kick tires. Using my well-practiced technique, I started at the top of an I/O module and worked my way down:

Preamp gain switch controls microphone gain from 10 to 60 dB in 5 dB increments. Underneath is a phase-reversal switch.

High-cut filter button cuts at 15 kHz at 12 dB/octave. Low-cut filter button cuts at 30 Hz at 12 dB/octave.

Line input gain switch controls the line input amplifier from -20 dB to +20 dB in 5 dB increments. Underneath is a line input select switch selecting mic preamp output or line input. Line output pot continuously varies gain from -70 dB to +12 dB.

A solo button accesses the line output.

High-cut frequency switch selects roll-off from 5 kHz to 15 kHz at a 12 dB/octave slope. Underneath is a low-cut frequency switch to select roll-off from 30 to 480 Hz with a 12 dB/octave slope. Close by are the high-cut filter on/off button and low-cut filter on/off button.

High-frequency equalization switch cuts or boosts from -14 dB to +14 dB above 10 kHz in 3 dB increments. Underneath, a low-frequency switch cuts or boosts from -14 dB to +14 dB below 100 Hz, in 3 dB increments.

Mid-frequency equalizer gain switch selects a cut or boost from -14 dB to +14 dB in 3 dB increments. Underneath, the mid-frequency center switch selects a center frequency from 150 Hz to 7 kHz.

Equalizer in/out button.

Send 1 and 2 level pot controls the gain of sends 1 and/or 2 from -75 dB to +12 dB. Underneath, a pre/post switch selects the send outputs from either before or after the VCA fader.

Send 1 and 2 buttons connect a channel output to a send, or if both are depressed, a post-fader stereo pan is fed to Send 1 (left) and Send 2 (right).

Send 3 and 4 level pot and pre/post switch duplicates the 1 and 2 sends.

Send 3 and 4 buttons connect a channel output to the sends. Pan pot controls left and right two-mix outputs. Underneath, a group switch assigns the channel VCA fader and mute to 1,2,3,4 sub-groups or local.

Mix A and B buttons connect panned two-mix outputs to either mix A, B, or both.

Mute button mutes channel VCA fader.

Solo button provides stereo panned output.

VCA fader controls DC gain level to channel VCA.

PFL button routes pre-VCA signal to PFL speaker.

controls mix A stereo output and the send 1 and 2 outputs, while the other handles mix B and sends 3 and 4.

Limiter on/off button.

Limiter screwdriver adjustment sets hard limit level from +4 dB to +26 dB, and soft level 3 dB below hard level.

Release pot sets compressor release time from 10 ms to 200 ms. Underneath, an attack pot sets time from 2 ms to 20 ms.

Threshold selects compressor level from -40 dB to +10 dB. Underneath, ratio selects compression ratio from 1:1 to 20:1.

Compressor on/off button with LED indicator.

Send level 1 (or 3) controls output level. Send 1 (or 3) mute button.

Send level 2 (or 4) controls output level. Send 2 (or 4) mute button.

An 83-mm master fader level control for stereo mix A (or B).

And, of course, on the lower parts of the modules were subgroups two and three. But I still wasn't done—it's the monitor module that makes the engineer's life easy or otherwise.

BNC connector for gooseneck lamp.

Solo level controls level of solo-to-monitor and headphone from -75 dB to +12 dB.

Air select buttons route signal to air output. (ident, mix A, mix B, aux)

Monitor input buttons route signal to monitors and headphones. (air, ident, mix A, mix B, aux, S1-2, S3-4, BDCST, tape)

Mono button mutes right speaker and sums stereo output to left.

Mute L button mutes left monitor. Mute R button mutes right monitor.

Monitor level controls level from -75 dB to +12 dB.

Monitor speaker mute.

Fourth sub-group mute and fader.

Clearly, this is an I/O module to be reckoned with: obviously scaled down from the big consoles, yet still retaining all the essentials. At least the long-arm stretch wasn't required. But what about the master modules? I turned my eye to the communications module—as far as studio recording goes, the most extraneous part of a board. If MCI wanted to cut corners, it would show up here.

Condenser talkback mic.

Mic pot controls level of comm mic.

Foldback select buttons.

Oscillator-select buttons. Includes white and pink noise, and warble. Oscillator level pot.

COX (communications-operated relay) level to screwdriver-adjust external comm mic voice-operated relay level set.

PFL level control to speaker.

PFL mute button routes PFL to right monitor only. When unmuted, PFL is routed to PFL speaker.

COMM level screwdriver adjustments for the level of three external comm mics.

Slate button, comm buttons route talkback mic to comm headphones, cue button connects talkback mic to selected sends.

So, it's a fully adequate communications module—but who cares? The only person who uses it is the producer, and what does he know? What about something important, like the returns? I cast my glance on the return module. Each of the first two mono returns were identically equipped.

S1 and 2 button feeds panned output to sends 1 and 2.

Return level pot controls level of return from -75 dB to +12 dB. Underneath, a pot pans the return between left and right mixes or between send 1 and 2.

Mix A and B buttons feed the panned return output to either or both of the two-mix buses.

PFL button feeds pre level return to PFL monitor.

Solo button provides stereo-in-place solo of the return.

Mute switch disconnects the return from all buses.

ACCURATE TAPE TENSION MAKES BETTER RECORDINGS

If something SOUNDS FISHY it may be your fish scale approach to measuring tension.

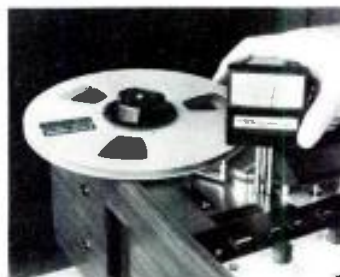

The Tentel Tape Tension Gage is designed to diagnose problems in your magnetic tape equipment. Virtually all recorder manufacturers use and recommend the TENTELOMETER® for use with their equipment.

The TENTELOMETER® measures tape tension while your transport is in operation, so you can "see" how your transport is handling your tape: high tension causing premature head and tape wear, low tension causing loss of high frequencies, or oscillations causing wow and flutter. Send for the Tentel "Tape Tips Guide". The T2-H20-ML sells for \$279 - complete.

TENTEL
1506 Dell Avenue
Campbell, CA 95008
(408) 379-1881
Toll Free 800 538-6894 (ex. CA)

Similarly, the third return provides the above features for the stereo return. An added balance button engages the stereo balance control, which takes the place of a return pan. The lower part of the module contains the first sub-group mute button, and sub-group fader.

Okay, so the return module is comprehensive, but how can you go wrong with a simple return? I turned my attention to the two identical master modules, noting that one module

The top panel is well-equipped, that's obvious, but as every professional knows, the knobs are there mainly for show. The really important part of a console, especially a portable one, is how the back panel is designed. I walked around and took a look. Each input module has three quarter-inch jacks and two XLR connectors. The top jack provides for a fader voltage break point, so the channel VCA can be remotely controlled for muting or ramping. Another jack provides for channel line output, nominal +4 dB output, for example, to a multi-track tape recorder. The third jack is an equalizer break point, for external equalization. The top XLR connector is channel line output, the bottom XLR is microphone input. Three toggle switches on each I/O module provide for phantom power on/off, line input shield lift, and microphone input shield lift. The lift switches made me hesitate—had someone at MCI actually consulted a remote engineer before they designed this console?

The return module has three XLR connectors, for return 1, 2, and 3 inputs. Also, three toggle switches provide for shield lifts on all three returns. The master modules together contain eight XLR connectors, for mix A and B outputs, left and right channels, and send 1, 2, 3, and 4 outputs. The fact that MCI hadn't put lift switches on the outputs made me even more suspicious that they had consulted with somebody. The communications and monitor modules use 30-pin Tuchel connectors (shell 2944-000 and insert 2070-030) for all inputs and outputs—a real convenience, if you have the right harness. Along the bottom of the console back panel are six snake connectors: microphone input, console outputs, line

outputs, DC switching, line inputs, and ganging connections. Finally, there is a DB-25 connector for broadcast applications—remote on/off-air switches, remote ready, on/off-air status, and ready status. I stepped back from the



The MCI JH-800 Compact Console

console and wiped a bead of perspiration from my forehead; this is a lot of stuff in a small package. But I don't believe anything about a console until I look at an I/O module. Each module is secured with two allen screws and is easily withdrawn with the familiar MCI handle. The top panel with fader, circuit card and rear connectors and switches are contained in one unit with a Faraday shield covering the bottom of the circuit card. The temptation to use right-angle XLR connectors soldered directly to the circuit card has been avoided—the connectors are secured to a metal plate; the pins

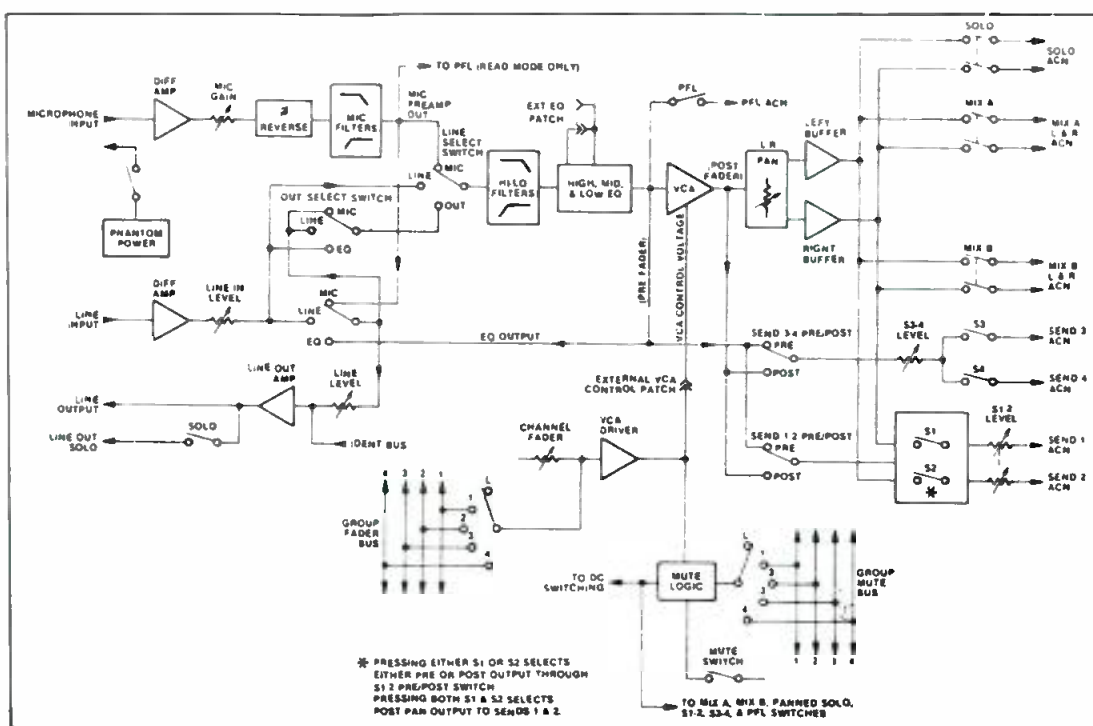

JH-800 I/O signal flow

are soldered to a small circuit board which is attached to the metal plate and electrically attached. It's mechanically, and effectively, decoupled from the main card, with bus strips. Connections to the motherboard are made via three European multi-pin connectors.

Each I/O module is populated with MCI 2004 (5532 dual op amp) and TL 072 op amps (7 of the former packages and 1 package of the latter). The VCA, contained in a SIP package, is courtesy of dbx. The only other active integrated

output. Maximum output at the mix and send outputs is +24 dBv, output noise floor with no channels assigned is -90 dBv, output distortion is less than 0.05 percent THD at 1 kHz, and cross talk is less than -75 dB at 15 kHz. I wouldn't have time to test any of those specifications, but I believed them, just as I believe any manufacturer's published specifications. (I also believed in Santa Claus and the tooth fairy.)

I sat down at the desk—it was a good console. As a full-

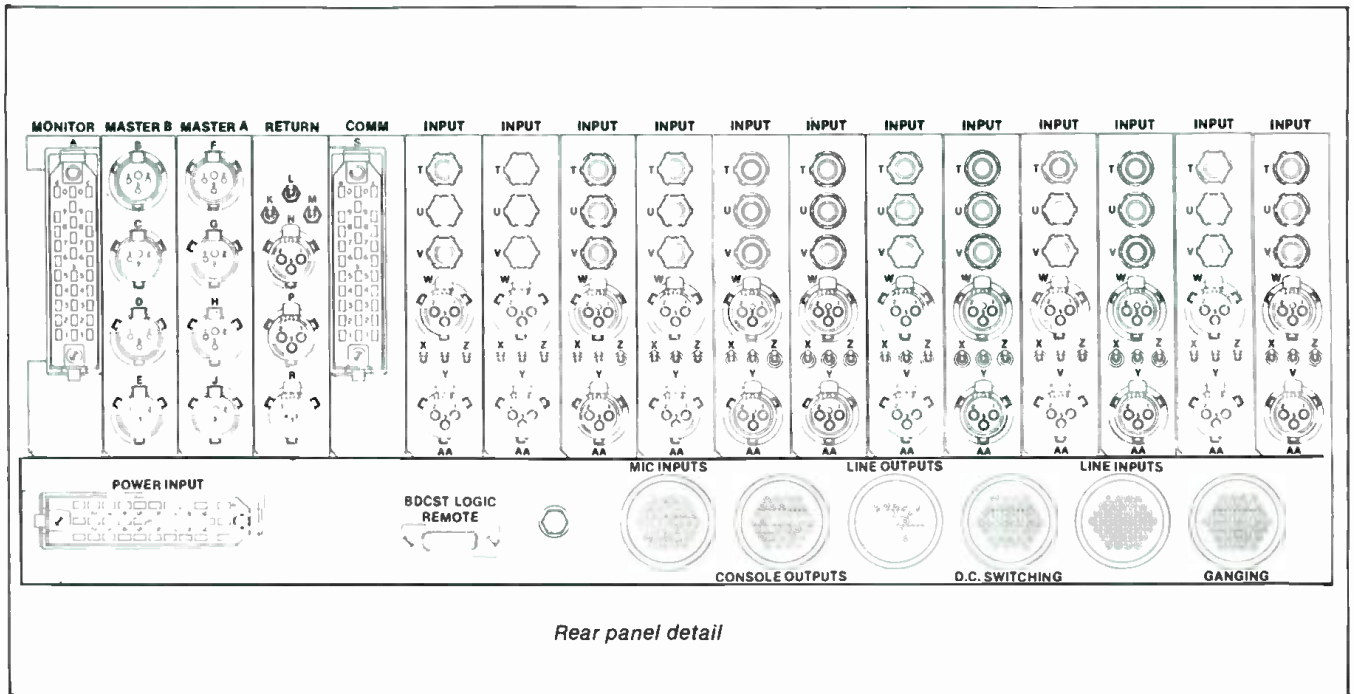

circuit is a 7474 dual flip-flop, controlled by the channel mute switch. All ICs are socketed, a maintenance advantage. A quick look at the circuit card shows evidence of careful design—the mic preamp design is a familiar yet excellent choice. Large valued decoupling capacitors are used throughout. Bourns and Stackpole sealed switches are used, as are sealed miniature relays. Both line and mic inputs are balanced, active, without transformers and include rf noise traps using matched components. The mic rf trap is constructed from a pair of matched 910 micro-henry chokes, three pairs of matched capacitors, and two pairs of matched resistors, with rejection to DIN standard 45410. Except for the rf traps, no bandlimiting is used in the I/O modules. Thus, high-frequency response through the op amps is very good. Precision linear faders (Penny and Giles type PGF) determine gain control for the VCAs. N-channel J111 FET switches connect the panned mix output to the ACN buses. The high and low shelf equalizers are Baxendalls and the mid peak is Wien. The input modules can provide status outputs to external devices; jumpers permit either normally-open or closed relay contacts. A VCA distortion null adjustment requires an extender board, but is easily accomplished. All components are of fine quality, circuit board layout is very good, as is overall construction. What's more, the modules on this pre-production model were devoid of wired jumpers or cut traces.

I put the module back, it looked pretty good—seemingly well designed and well made. Then I turned back to the book and glanced at the specifications. The microphone preamplifier claims a maximum in-out level of +10 dBv referenced to 0.775 VRMS, and an equivalent input noise of -127 dBv, referenced to 0.775 VRMS. Distortion is less than 0.1 percent 1M and less than 0.05 percent THD. Maximum input at the line input is +28 dBv, and equivalent input noise is -94 dBv. Maximum output level is +22 dBv at the line

fledged, down-scaled professional recording console it may outclass most everything else in its size range. However, its \$18,000 price tag places it above that strata of the market that caters to semi-pro applications. Clearly, in terms of original intent and finished outcome, this is a serious console. And yet as far as this particular board was concerned, it was all academic. As I watched, a team of student goril... I mean recording engineers, carried it away. Oh well, it was a good console, while it lasted.

I was astounded, I was disconsolate. The students came back from the jazz concert, from the symphony, from the rock class, with the console still in one piece—not even scratched—and accompanied by accolades. They had been unable to destroy it. Moreover, they *liked* it! They reported: quick to set up, easy to use, smooth-sounding response. I was chagrined, and suddenly envious. Clearly, I would have to test this console myself, with the ultimate test. I picked up the phone and gave Carlos Santos a call; we were taking this board to the opera.

ON TO THE OPERA

My old recording console is still perfectly acceptable. In fact, it's been an outstanding performer. It has plenty of spare inputs, adequate equalization, phantom power, and it has never had catastrophic failure during a recording. But it isn't perfect—its meters are mickey-mouse, it has a noise floor that always comes through loud and clear, and a coloration which I had long ago gotten tired of hearing in all my recordings. Yet five years ago it cost about a tenth of what this new MCI costs today. For that kind of money, things like convenience or ease of set-up don't really count. I decided that only one factor could be used to judge the MCI as being worth its cost—what does it sound (or *not* sound) like?

We parked the van behind the opera house. In the time-honored tradition of roadies everywhere, Carlos and I started off-loading the lightweight stuff first. Carlos is new to the

opera gig, but his professional intolerance to imperfection (plus a Latin flair for recklessness) made him a perfect choice for this test of the MCI console. We carried it up to the control room—definitely a two-man job.

We hung microphones for a few hours, then retired to the control room to set up the studio. All of the monitor functions are interfaced through a Tuchel connector, but we lacked that harness and thus couldn't use any of those features. Instead, we drove the monitors through the tape machine. A couple of standard connectors in and out would have been nice. We attached the console to its power supply with the Tuchel power cable (one of the world's nicest connectors to use) and powered up. The house has badly-grounded AC which affects some equipment—I checked some voltages and found close tolerances with no noise; I also noted the comforting presence of triacs for overvoltage protection. I turned on phantom power for the condenser channels, and brought up some faders—a pair of shotguns had a buzz, and a pair of SM-81s were dead. Aha! I *knew* this console wouldn't make it—we had never had such problems before. I reached around back and tried the mic shield lift switches—the 81s came up, the buzz disappeared, and I put in a thanksgiving prayer for lift switches. But why make the engineer fish for them, way in the back—how about up front, hidden under an armrest or something? A quick check of gain structure from an external oscillator uncovered nothing noteworthy. In general, it appeared that the headroom specs were accurate. The meters themselves didn't thrill me—those green fluorescent jobs you find on cassette machines—they detracted from the professionalism of the board. And, they were horizontally placed (to avoid having them confused as channel meters?), a little disorienting after working with vertical meters for so long. And, why not channel meters? I think there would have been room for them (vertically placed) on the meter turret. In the absence of channel meters, a solo meter or at least overload LED indicators on each I/O module would have been valuable to help locate over-worked inputs. The rehearsal was underway. We killed the lights to avoid an obscene intercom call from the lighting designer, the little BNC-connector gooseneck lamp was totally insufficient—too dim. I couldn't see the markings, especially since the layout was unfamiliar to me. We put up another light, and covered it with red gels.

We tried a few things. The high- and low-cut filters were nicely imperceptible—I left the low cuts in to guard against air-conditioner rumble. The various on/off push buttons for filters, mix select, solo, etc., are somewhat hard to see. When depressed, they are about an eighth-inch lower than otherwise; I found myself pushing and un-pushing just to make sure of the mode. LED indicators might be too expensive—but how about buttons with some throw to them? The channel mute switch #1 jammed—defective switch. We began to listen, and tried some equalization. The band EQ seemed to have a Q that was slightly too high—an MCI trademark, in my opinion. The gain/center knobs on channel 11 were intermittent and a high-gain setting produced feedback in the mix. We switched channels. The equalizer in/out switches were noisy—we could clearly hear the pop as we monitored through the tape machine. Some were worse than others—channel 9 produced an audible discontinuity in the channel when switched. Apparently the switches used are not shorting switches. Thus, a discontinuity is almost inevitable. Perhaps a resistor around the switches could solve this problem. Meanwhile, we decided it would be best not to change modes when tape was rolling. When in doubt, leave the equalizer in, but adjusted flat. In addition, other switches such as mix select produces minute glitches in our mix bus. Is this a problem local to our pre-production model, or a basic design problem? A look at the schematic revealed design flaws—on several opamp outputs following the coupling capacitor there was no resistor to ground to bleed off DC offset voltage. The result: potential for pops.

My biggest complaint came with sudden cognizance as I

employed a mic trim: The mic trims are 5 dB increment switches. With these discontinuities, trimming cannot be attempted during a recording—the steps are obviously audible. While some applications might call for trims that can be varied and returned to a previous setting, this design feature prohibits the real-time use of trims to consolidate fader positions. A continuously-variable pot with indented positions would have been far superior, in my opinion.

We tried the compressor, with reasonable results. However, we thought the threshold adjustment was too touchy. In general, the gain changing sounded fine, but after playing with it for awhile, we decided to be very conservative with the compressor—just enough to control some artillery shots in the opera. We tried the sends and were momentarily fooled until we figured out that the send buttons which feed the return output to the ACNs are *off* when depressed and *on* when up—contrary to all the other pushbutton switches on the board. We tried to send some oscillator tones to the tape machine but discovered that the oscillator feeds the ident bus and a slate connector—not accessible to us at the moment. Perhaps with more cleverness we could have found a way to route the tones to the tape machine, but we gave up and used an external generator instead. Incidentally, while looking for the test tones, we heard a fair amount of bleed to the two mix, indicating cross talk—an especially dangerous condition in a production application where the buses are always carrying diverse signals. Other minor problems included some dual-concentric knobs which only stubbornly would move independently of each other—the familiar two-handed knob turn needed to be employed. I concluded my list of complaints with the fact that the headphone jack is located on the right side of the console front, so the headphone cord is always ready to tangle with you when you're using the master modules. A left side placement would have been more ergonomic.

THE VERDICT

Finally, we got down to business. We found a good microphone balance and sat back and listened—same microphones, tape machine, amplifier, and speakers we used for the last opera. But this MCI console made it all sound a lot better. In fact, it sounded fabulous. The noise floor was down where it should be in a professional analog console, the high end was very clean, and the low end was a revelation of smoothness and solidity. In my opinion, the little board sounded better than our studio's 500 series. In all fairness, our 500 is a very early pre-production model, yet this little 800 is an early pre-production model also. Carlos took the piece of paper with our complaints and tore it into little pieces. I couldn't have said it any better myself. Clearly, compared to this MCI, my old portable console belongs in the trash.

As far as the console's operation during the opera performances—there is nothing to report. Quite rightly, it merely amplified and processed the signals, and never interfered with the music. The incremental mic trims and switch noise were unfortunate liabilities and prohibited any use of these controls while rolling tape, but when we tore the studio down following the last performance, we had cleaner tapes than ever before. However, as far as purchase goes, for my modest purposes, it was simply too much quality. For remote classical recordings I had no use for the broadcast features, sends and returns, or subgroups. While the package is ideally suited for broadcasting, audio/video production and recording studios, it wasn't for me. On the other hand, I reflected that perhaps MCI would sell me a half dozen I/O modules and a master module...

The review period had ended, regretfully. I took the board back to MCI, and delivered it to Lutz Meyer, Vice President of Marketing. He asked me what I thought of it. I looked him in the eye and gave him the hard truth:

"She's a beauty." ■

New Products

VOLTAGE MONITOR/ SURGE SUPPRESSOR

- The Model CMP-905 Voltage Monitor & Surge Suppressor is equal to or better than a dedicated line performance, and provides optimum transient performance that complies with the IEEE standard. The CMP-905 consists of a Lexan housing, a visual line voltage monitor, an internal overload fuse, and one outlet that may be used in conjunction with a multiple outlet bus strip. A fast-action, high capacity metal oxide varistor (MOV) diverts voltage transients before system damage can occur. A two-pole LC filter reduces EMI/RFI noise pollution to well below danger levels. The visual voltage monitor is an LED which glows a steady green, yellow or red depending on incoming voltage levels. Should the unit ever be incapable of suppressing a voltage transient, the light changes to an on-off warning blink. The CMP-905 may be used to protect all micro-electronic equipment from destructive voltage surges and EMI/RFI noise pollution. It also prevents logic errors, memory loss, erroneous read-outs, mis-indexed programs, PC board failure, and total system failure caused by voltage transients.

Mfr: Nortronics
Price: \$159.00

Circle 43 on Reader Service Card

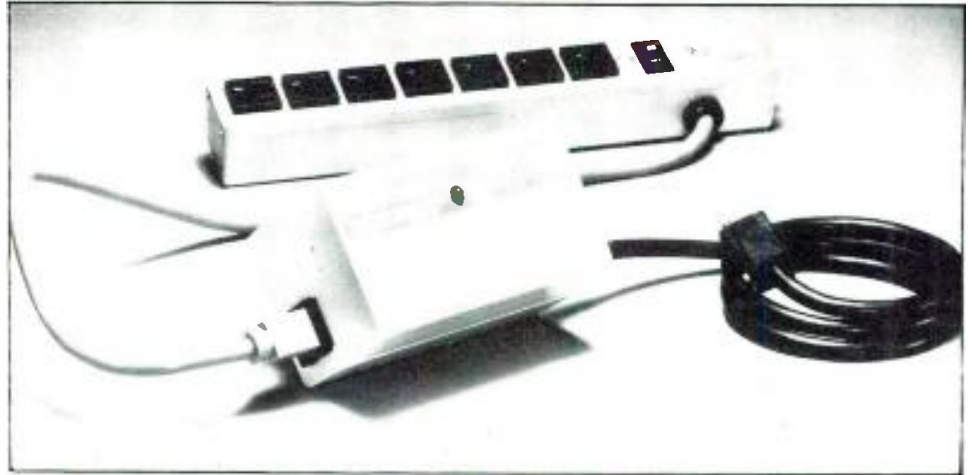

EDIT CODE READER

- Designed to withstand hostile environments, the Model 646 edit code reader/raster display reads either SMPTE or EBU Code and displays data on the front panel in eight digit, 1/2-in. high LED numerals. The unit also allows the user to key in the data on video raster in either black letters on a white background or in reverse. Readable tape speed is from 1/16 to 40X. User code can be displayed by a front panel selection switch. The Model 646, designed for both studio and mobile applications, is rack mountable and measures 19 inches wide by 16 inches deep and 1.75 inches high.

Mfr: Shintron Company Inc.
Price: \$1500.00

Circle 44 on Reader Service Card



STROBE LIGHT SIGNALLING DEVICE

- The industry's first strobe light signalling device for telephone systems emits a high intensity flashing light when a telephone rings, making it ideal for effective visual signalling where distance from a telephone or high ambient noise makes it difficult to hear a phone ringing signal. A solid-state relay incorporated in the circuit design has a low ringer equivalent that permits multiple station hookups off the same circuit without concern for line overloading. The device is designed for a wide tolerance of variations in ringer input voltage: 150 V max. to 40 V min., with 90 V, 20 Hz typical. Light output is 70K peak candle power. A line cord for AC power and a standard modular jack at the base of the unit for simple connection to existing telephone lines are provided. The new telephone strobe signalling device will be available in the third quarter of 1983.

Mfr: Wheelock Signals, Inc.

Circle 45 on Reader Service Card

Classified

Closing date is the fifteenth of the second month preceding the date of issue.

Send copies to: Classified Ad Dept.

db THE SOUND ENGINEERING MAGAZINE
1120 Old Country Road, Plainview, New York 11803

Minimum order accepted: \$25.00

Rates: \$1.00 a word

Boxed Ads: \$40.00 per column inch

db Box Number: \$8.50 for wording "Dept. XX," etc.

Plus \$1.50 to cover postage

Frequency Discounts: 6 times, 15%; 12 times, 30%

ALL CLASSIFIED ADS MUST BE PREPAID.

FOR SALE

THE RECORDING BOOK THAT IS ROCKING THE MUSIC INDUSTRY

"Practical Techniques for the Recording Engineer" by Sherman Keene is endorsed by major colleges, universities, recording schools, studios, musicians and our correspondence students around the world. Recommended by reviewers of the MIX, Re/P, Guitar Player and other top publications. The book—hard cover, 380 pages, 28 chapters (4 on computer assisted mixing), illustrations. \$29.75 (\$31.69 in Calif.) + \$2.50 for shipping. The Correspondence Course—certificate course using two textbooks, corrected and graded homework, cassette dialog with the author via cassette. Basic, Intermediate, and Advanced Levels. The Curriculum—for schools only, Teacher's manual (lesson plans for two textbooks, charts, suggested session content), Student's Workbook, Final Exams. For information or to order, contact: **S.K.P., 1626 N. Wilcox, No. D-677, Hollywood, CA 90028.** Order by phone using Visa or Mastercharge by calling (213) 708-2933.

FREE 32pg Catalog & 50 Audio/Video Applic.
PWR SUPP. EQ.
PHONO, MIC,
TRANS. ACM
TAPE, VIDEO
LINE, OSC
Stereo Mono Pwr Ampl
Video & Audio Dist Amp
TV Audio & Recd Prod Consoles
OPAMP LABS INC (213) 934-3566
1033 N Sycamore Av LOS ANGELES CA, 90038

FOR SALE—AKG C-24 and other tube type condenser mics. (415) 441-8934 or 527-6167.

TUBE MICS

- 2—Mint U-47's—1650.00 ea.
 - 2—M49b, consecutive serial numbers. 3500.00 a pair.
 - 2—AKG C-28's, beautiful. 700.00 ea.
 - 2—KM54A Neumann—450.00 ea.
 - 1—KM56 Neumann—600.00
 - 1—SM-2 Stereo Neumann. 1500.00
- Call Bill at (312) 751-1216. Please leave a message if you get my machine.

BLANK AUDIO AND VIDEO CASSETTES direct from manufacturer, below wholesale, any length cassettes: 4 different qualities to choose from. Ampex and Agfa mastertape—from ¼-inch to 2-inch. Cassette duplication also available. Brochure. **Andol Audio Products, Inc., Dept. db, 42-12 14th Ave., Brooklyn, NY 11219. Toll free 1-800-221-6578, ext. 1, NY residents (212) 435-7322.**

Would you believe REAL-TIME cassette copies for \$1.03 each? Exquisite sound, modest cost. Denon DR-F8 Recorders, AGFA Tape. Full-color printing and assembly available. America's most experienced Real-Time Duplicators. **Contact GRD (602) 252-0077, P.O. Box 13054, Phoenix, AZ 85002.**

THE LIBRARY... Sound effects recorded in STEREO using Dolby throughout. Over 350 effects on ten discs. \$100.00. Write **The Library, P.O. Box 18145, Denver, CO 80218.**

TECHNICS TURNTABLES IN STOCK! AKG, Neumann, UREI, Orban Eventide, dbx, Lexicon. Best pro-audio equipment. Lowest prices. IMMEDIATE DELIVERY. **UAR Professional Systems. (512) 690-8888.**

USED RECORDING equipment for sale. **Dan (415) 441-8934.**

MCI JH24B, JH100 16 track, locator, mint \$13,500.00. Electrodyne 16 x 8 console. \$3,500.00. Ampex AG 440, 7.5. ½ tk., \$1,800.00. (513) 258-2463.

REELS AND BOXES 5" and 7" large and small hubs, heavy duty white boxes. **W-M Sales, 1118 Dula Circle, Duncanville, Texas 75116 (214) 296-2773.**

NEUMANN U-87, U-47, four each. Used once. In warranty. \$849, \$829. Call John (512) 690-8187.

MICROPHONES. Immediate delivery via UPS. All popular models in stock. Best prices you'll see in '83; PLUS we pay freight. **UAR Professional Systems, 8535 Fairhaven, San Antonio, TX 78229. (512) 690-8888.**

DIRECT FROM BROADWAY

USED SOUND EQUIPMENT SALE

PETER PAN • FIDDLER • CAMELOT
KING & I • CHORUS LINE • DOLLY
Wireless Microphones
Used By The Stars
AMPS • MIXERS • RECORDERS
all guaranteed

SOUND ASSOCIATES, INC.
424 WEST 45 ST. • N.Y., N.Y. 10036
TELEPHONE 212-757-5679

PRO AUDIO IN STOCK—ready to ship. Top lines, top dollar trade-ins, clearance specials. Call or write for our prices. **Professional Audio Video Corporation, 384 Grand Street, Paterson, NJ 07575 (201) 523-3333.**

FOR SALE: SCULLY 284-B 8-TRACK little used. Make offer or \$5,600 takes it. QUANTUM 128 12 x 8 CONSOLE in producers cabinet. \$3,700. **Thelen Advertising, MN (612) 253-6510.**

FOR SALE: Scully "The Lathe," Nikon Scope, Ikegami camera and monitor, Ortofon DSS-732 Cutter. Custom amps, Nikon stylus inspection scope. All As New. \$45,000.00. **Call (305) 947-5611, CRITERIA RECORDING STUDIOS, 1755 NE 149th Street, Miami, FL 33181.**

WANTED

WANTED: TRANSCRIPTION discs, any size, speed. Radio shows, music. **P.O. Box 724-db, Redmond, WA 98052.**

SERVICES

MAGNETIC HEAD relapping—24 hour service. Replacement heads for professional recorders. **IEM, 350 N. Eric Drive, Palatine, IL 60067. (312) 358-4622.**

ACOUSTIC CONSULTATION—Specializing in studios, control rooms, discos. Qualified personnel, reasonable rates. Acoustilog, Bruel & Kjaer, HP, Tektronix, Ivie equipment calibrated on premises. Reverberation timer and RTA rentals. **Acoustilog, 19 Mercer Street, New York, NY 10013. (212) 925-1365.**

MOVING?

Keep **db** coming without interruption!

Send in your new address promptly.

Enclose your old **db** mailing label, too.

Write to:

Eloise Beach, *Circ. Mgr.*
db Magazine
 1120 Old Country Rd.
 Plainview, N.Y. 11803

EMPLOYMENT

SYSTEM DESIGN ENGINEERS

OVERSEAS ASSIGNMENTS IN ASIA. U.S. company with offices in San Francisco, Brunei, Singapore and the Philippines actively engaged in engineering design of electronic systems and contract installations for building complexes in Asia—specializing in the systems:

- Building Automation
- Energy Management
- Life & Asset Safety Systems
- **Commercial Sound Systems**

Will consider applicant for these positions with the following qualifications: • 3-5 years experience in System Design, Installation, Project Engineering, Testing/Instrumentation, Calibration and Operation of any of the above systems. • Knowledgeable in Acoustic Analysis. • College graduate. Qualified candidate must be willing to travel around Asia for Project assignments. Willing to sign a 3 year minimum contract and be available by June-July 1983.

Interested parties send resume with present and desired salary; references and professional recommendations from previous employers will be helpful in evaluation. All applications should be mailed to **P.O. Box 2244, South San Francisco, CA 94080.** Qualified applicants will be advised by phone for personal interview to be scheduled.

**TECHNICAL SUPPORT ENGINEER/
 CASSETTE DECKS**

Fort Wayne, Indiana firm has immediate opening to manage warehouse and service functions for automotive cassette deck product line.

Limited travel is required. Responsibilities include continuous interface with customer engineering and quality control staff, incoming and outgoing quality assurance at the warehouse level, training and supervision of technicians and repair people.

Applicant should have a strong electronics background (BSEE preferred) as well as experience in tape products. Salary is negotiable and commensurate with experience. Submit resume to **P.O. Box 15542, Fort Wayne, IN 46885.**

**BUY
 SELL
 TRADE**

IN



Have you misplaced your **db** again? Our high quality, royal blue vinyl binders keep 12 copies of **db** neat and handy for ready reference. Just \$9.95, available in North America only. (Payable in U.S. currency drawn on U.S. banks.) **ORDER YOURS NOW!!**

Sagamore Publishing Co., Inc.
 1120 Old Country Road
 Plainview, NY 11803

YES! Please send **db** binders @ \$9.95 each, plus applicable sales tax
 Total amount enclosed \$

Name
 Company
 Address
 City
 State Zip

Happenings

Denon Digital Disc Player On Trial

• WNCN (Classical 104.3 FM) has installed—on loan from Denon—a digital compact disc (DC-2000) player. The revolutionary new player, which is a laser-read device for playing back digitally-recorded compact discs (also provided by Denon), has been sold in Japan since October 1982. Within the last few months, it has also been made available in the U.S. for demonstration purposes.

The DCD player and digital compact discs (also referred to as digital audio discs) greatly enhances the quality of sound. The 4-inch disc allows up to one hour of playing time on one side. It has a 90 db dynamic range and 90 db signal to noise ratio, producing virtually noise-free sound. There is no hiss, nor clicks, pops and other distortion.

WNCN has begun on-the-air testings

of the new equipment. This is the first step in the station's plans to purchase a DCD player.

It's MAC Time

• The subject of the 1983 Midwest Acoustics Conference will be "Audio Signal Processing." The topic will be approached from several important applications areas: Recording and Playback, Measurement and Instrumentation, Speech Generation and Recognition, Music and Sound Generation, Telecommunications, and Hearing Improvement. Each of the MAC 83 speakers is expert in his field and actively involved in state of the art applications. Recent trends in both digital and analog technology, fast Fourier transform techniques and

features of digital transmission will be discussed.

The conference will be held at Hermann Hall, Illinois Institute of Technology, Chicago, Illinois, on Saturday, April 23, 1983, from 9:00 a.m. to 5:30 p.m. Several manufacturers of state of the art transducers and instrumentation will be exhibiting and demonstrating their products in addition to the formal presentations.

Midwest Acoustics Conference is sponsored by the Chicago Acoustical and Audio Group, the Audio Engineering Society, the Chicago Regional Chapter of the Acoustical Society of America, the Chicago Section of the Institute of Electrical and Electronics Engineers, and the IIT Research Institute.

For additional information, see the M.A.C. ad on page 16.

Gone Video

• One of Washington DC's foremost audio engineering and production companies has gone video. Techniarts Video has begun operation with a \$1M editing suite designed to accommodate the most demanding video producer. The facility comes complete with four machine CMX editing, two channels of digital video effects, Chryon graphics, and the most powerful CDL production switcher available. To enhance the system's capability, Techniarts built a spacious, acoustically designed control room with an adjoining 12,000 cubic foot insert stage and sound studio.

Techniarts' engineers chose a new system built by CDL to couple their Rupert Neve mixing desk through the audio chain to the recorder inputs. For audio sweetening, they have time code interlocked an Ampex ATR-104 through the editing system and then added a full range of studio signal processors, including dbx noise reduction, for track correction and enhancement. The audio monitor system utilizes UREI time-aligned monitors with full 1/3 octave room equalization.

Adjacent to the editing suite, the sound studio and insert stage have been acoustically treated and made capable of supporting a wide variety of camera shooting and/or audio overdub requirements.



The editing suite at Techniarts.

Finally. On-Air Boards Designed By Broadcasters!

The UREI Broadcast Consoles

Before we started designing the new Series 1650 and 1680 consoles, we talked to you... engineers, jocks, announcers and consultants. Then we went to the drawing boards to plan a line of on-air boards with the features you wanted... built with UREI's traditional quality and reliability.

The result is a fresh answer to the operational requirements of the broadcaster of the '80's. Six all-new on-air boards... choice of 5 mixers (1650 Series) or 8 mixers (1680 Series)... choice of Penny & Giles slide pots, Shallco or conductive plastic rotary attenuators... +24 dBm output... better than 90 dB signal to noise ratio... inputs from +8dB down to -10 dB... built-in cueing amp and speaker.

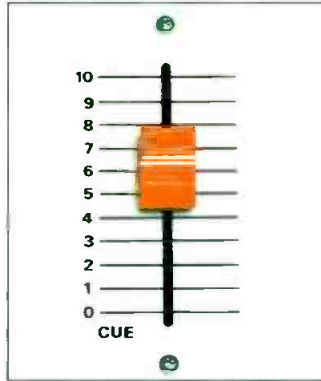

Best of all, both Series are competitively priced!

Ready to Go

You can customize the new UREI consoles, but no accessories are required to go on the air. They are supplied with full sets of input preamps. All preamps are interchangeable in all positions. We even designed a new acces-

sory phono preamp for these new boards that mounts at the turntable and takes its power from the console. Ask about the Model 1101 Phono Stereo Preamplifier.

The Modern Ones

You've been asking for a new line of UREI on-air consoles for years. We took the time to make them "the modern ones"... the ones that will meet your requirements through the 80's and beyond. For more information on the UREI Broadcast Consoles, see your authorized UREI dealer, or write:

From One Pro to Another 

United Recording Electronics Industries
8460 San Fernando Road
Sun Valley, California 91352
(213) 767-1000 TLX 472 0889 UREI SNVY
Canada: E. S. Gould Marketing, Montreal



The Ampex ATR-800 is built to last.

Others talk about audio "workhorses". But only Ampex has been manufacturing reliable professional audio recorders since 1947. Recorders that can take everything you can dish out day after day.

The Ampex ATR-800 continues our tradition by offering you unmatched editing ease, complete interfacing capabilities with a variety of peripherals (synchronizers, editors, etc.), a rugged cast transport that maintains tape path alignment, standard built-in features without an accompanying

premium price tag, and a full range of accessories for all kinds of applications. And, as with all Ampex audio recorders, you get our worldwide sales and service support to keep your workhorse racing along.

Try the ATR-800. Another winning audio workhorse from Ampex.

For details, contact your nearest Ampex dealer, or write Willie

Scullion, National Sales Mgr., Ampex Corporation, Audio-Video Systems Division,

401 Broadway, Redwood City, CA 94063.

OUR WORKHORSES DON'T DIE YOUNG.

AMPEX

Ampex Corporation • One of The Signal Companies



Circle 12 on Reader Service Card